

PRICE LIST

Prices valid from 1st February 2023



	Page
PALUX Topline Twin-Go Overview	5
Single-Pan Deep Fat Fryer	8
Single-Pan Deep Fat Fryer with electronic control Plus	8
Single-Pan Deep Fat Fryer with electronic control Plus and filter system	9
Single-Pan Deep Fat Fryer with electronic control Plus, filter system and oil pump	10
Dual-Pan Deep Fat Fryer	11
Dual-Pan Deep Fat Fryer with electronic control Plus	11
Dual-Pan Deep Fat Fryer with electronic control Plus and filter system	12
Dual-Pan Deep Fat Fryer with electronic control Plus, filter system and oil pump	13
Bain Marie GN 1/1	14
Vario Cooker GN 1/1	14
Vario Cooker GN 1/1 with top-mounted electric heater	14
Pasta Cooker GN 1/1	15
Pasta Cooker GN 1/1 with 2 automatic lifting baskets	15
Pasta Cooker GN 1/1 with 4 automatic lifting baskets	16
Vario Pan 400	17
Vario Pan 600	17
Vario Pan 800 CC	18
Vario Pan 800 SC	18
Vario Grill Pan	19
Vario Pan M	19
Vario Pan Plus GN 2/1 U	20
Griddle plate 400	21
Griddle Plate 600	21
Ceramic Range 1	22
Ceramic Range 2	22
Vario Range 1 (CNS)	23
Vario Range 2 (CNS)	23
Steak Grill 400 with drain on front side	24
Steak grill 400 with drain downwards	24
Steak Grill 600 with drain on front side	25

	Page
Steak Grill 600 with drain downwards	25
Steak Grill 800 with drain on front side	26
Steak Grill 800 with drain downwards	26
Induction Wok	27
Induction Range 1	27
Induction Range 2	27
Induction Range 3	28
Induction Range 4	28
Electronic Baking Oven GN 2/1	28
Gas Lava Stone Grill 600	29
Gas Lava Stone Grill 800	29
2-Burner Gas Range	30
4-Burner Gas Range	30
Work top	31
Work top with top-mounted electric heater	31
Work top with drawer	31
Topline Twin-Go Black Edition in colour variation	32
Accessories Deep Fat Fryer	32
Accessories Vario Cooker	32
Accessories Vario Range	32
Accessories Induction Wok	33
Accessories Vario Pan and griddle plate	33
Accessories Baking Oven	33
Accessories Gas Units	33
Side Panel	34
Lateral side part	35
Feet for Base cabinet TWG	35
Foot for Base cabinet Hygiene and electric baking oven UH	35
Plinth	35
Board on column	36
Splash guard for deep fat fryers	36

PALUX Topline Twin-Go - List of Contents

	Page
Adapter board	37
Handrail	37
Appliance connection / Side panel	37
Support for mixer	38
Product Code Base cabinet TWG & UH	39
Base cabinet as installation cabinet with folding door TWGIF	40
Base cabinet as installation cabinet with front panel TWGIB	40
Base cabinet as heated cabinet with sliding doors TWGWT	41
Base cabinet Hygiene open on both sides UHOS	42
Base cabinet Hygiene with folding door(s) UHFT	42
Base cabinet Hygiene with drawers UHSB	43
Base cabinet Hygiene with GN slides UHGN	43
Base cabinet Hygiene with garbage container UHMA	44
Base cabinet Hygiene for Vario Pan UHVB	44
PALUX Topline Twin-Go - Stated Dimensions	45
PALUX Topline Twin-Go - Heat Emission	46
PALUX Topline Twin-Go - Heat Emission	47

All indicated prices are net prices and are valid for a delivery within 6 weeks after placement of the order. If delivery has to be made later than 6 weeks after placement of the order, the prices will be adjusted according to the then valid price-list. All prices are per item. Our terms of delivery are: EXW Bad Mergentheim (according to Incoterms 2010), packing for land transport included, excluding vat. The prices mentioned in this price-list do not include installation of the appliances.

**All listed values are middle values and refer to normal operation.
Calculated in accordance with VDI 2052 04/2006.**

Subject to changes in power, dimensions and construction.

Single-Pan Deep Fat Fryer		Art. No.	Price EUR
with swivelling heating element in the pan		688339	
Dimensions (LxDxH):	400 x 838 x 320 mm	Direct heat emission:	0,72 kW
Load:	8,0 kW 400 V 3N	Latent heat emission:	5,60 kW
		Steam emission:	8,24 kg / h

☞ Control elements one-sided

Pan dimension: 220 x 340 x 190 mm

Pan content: 5.5l - 11l max.

Temperature: 103 - 180°C

- Accessories included:
- 1 x Appliance connection (690457)
 - 1 x Deep fat frying basket (271586)
 - 1 x Cover
 - 1 x Bread crumbs sieve
 - 1 x Handle for swivel fixture
 - 1 x Safety drainage valve

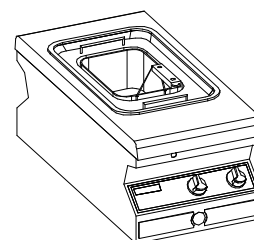

☞ When choosing the version with adapter board for thermal components and work tops, additional handles for swivel fixture have to be ordered / Cf. accessories.

Single-Pan Deep Fat Fryer with electronic control Plus		Art. No.	Price EUR
Swivelling heating element in the pan		891988	
Dimensions (LxDxH):	400 x 838 x 320 mm	Direct heat emission:	0,72 kW
Connected load:	8,0 kW 400 V 3 50/60 Hz	Latent heat emission:	5,60 kW
		Steam emission:	8,24 kg / h

☞ Control elements one-sided

Pan dimension: 220 x 340 x 190 mm

Pan capacity: 8.5 Litres - 11 Litres max.

Range of temperature: 50 - 190°C

- Accessories included:
- 1 x Appliance connection (690457)
 - 1 x Deep fat frying basket (271586)
 - 1 x Cover
 - 1 x Bread crumbs sieve
 - 1 x Handle for swivel fixture
 - 1 x Safety drainage valve

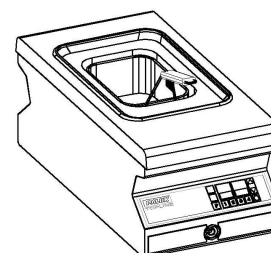

☞ When choosing the version with adapter board for thermal components and work tops, additional handles for swivel fixture have to be ordered/ Cf. accessories.

Single-Pan Deep Fat Fryer with electronic control Plus and filter system		Art. No.	Price EUR
Swivelling heating element in the pan		891989	
Dimensions (LxDxH):	400 x 838 x 750 / 900 mm	Direct heat emission:	0,72 kW
Connected load:	8,0 kW 400 V 3 50/60 Hz	Latent heat emission:	5,60 kW
		Steam emission:	8,24 kg / h

☞ Control elements one-sided

- Pan dimension: 220 x 340 x 190 mm
- Pan capacity: 8.5 Litres - 11 Litres max.
- Range of temperature: 50 - 190°C
- Base cabinet in hygienic version H2, closed on all sides with folding door (door hinging right)

- Accessories included:
- 1 x Appliance connection (690457)
 - 1 x Deep fat frying basket (271586)
 - 1 x Cover
 - 1 x Bread crumbs sieve
 - 1 x Handle for swivel fixture
 - 1 x Oil container
 - 1 x Coarse and fine filter

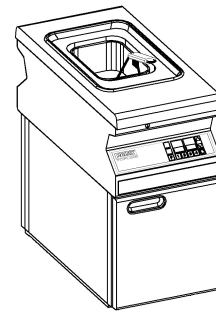

☞ When choosing the version with adapter board for thermal components and work tops, additional handles for swivel fixture have to be ordered/ Cf. accessories.

Single-Pan Deep Fat Fryer with electronic control Plus and filter system		Art. No.	Price EUR
Swivelling heating element in the pan		891990	
Dimensions (LxDxH):	400 x 838 x 750 / 900 mm	Direct heat emission:	0,72 kW
Connected load:	8,0 kW 400 V 3 50/60 Hz	Latent heat emission:	5,60 kW
		Steam emission:	8,24 kg / h

Base cabinet in hygienic version H2, closed on all sides with folding door (door hinging left)
Compare Art. No. 891989

☞ When choosing the version with adapter board for thermal components and work tops, additional handles for swivel fixture have to be ordered/ Cf. accessories.

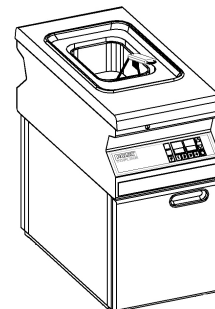

Single-Pan Deep Fat Fryer with electronic control Plus, filter system and oil pump		Art. No.	Price EUR
Swivelling heating element in the pan		891992	
Dimensions (LxDxH):	400 x 838 x 750 / 900 mm	Direct heat emission:	0,72 kW
Connected load:	8,0 kW 400 V 3 50/60 Hz	Latent heat emission:	5,60 kW
		Steam emission:	8,24 kg / h

☞ Control elements one-sided

Pan dimension: 220 x 340 x 190 mm
 Pan capacity: 8.5 Litres - 11 Litres max.
 Range of temperature: 50 - 190°C
 Base cabinet in hygienic version H2,
 closed on all sides with folding door (door hinging right)

Accessories included:

- 1 x Appliance connection (690457)
- 1 x Deep fat frying basket (271586)
- 1 x Cover
- 1 x Bread crumbs sieve
- 1 x Handle for swivel fixture
- 1 x Oil container
- 1 x Coarse and fine filter
- 1x Supply tap and hose

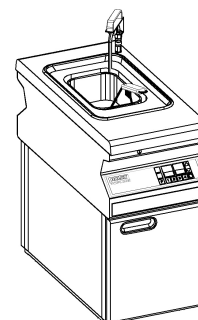

☞ When choosing the version with adapter board for thermal components and work tops, additional handles for swivel fixture have to be ordered/ Cf. accessories.

Single-Pan Deep Fat Fryer with electronic control Plus, filter system and oil pump		Art. No.	Price EUR
Swivelling heating element in the pan		891993	
Dimensions (LxDxH):	400 x 838 x 750 / 900 mm	Direct heat emission:	0,72 kW
Connected load:	8,0 kW 400 V 3 50/60 Hz	Latent heat emission:	5,60 kW
		Steam emission:	8,24 kg / h

Base cabinet in hygienic version H2,
 closed on all sides with folding door (door hinging left)
 Compare Art. No. 891992

☞ When choosing the version with adapter board for thermal components and work tops, additional handles for swivel fixture have to be ordered/ Cf. accessories.

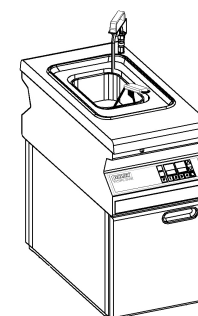

Dual-Pan Deep Fat Fryer		Art. No.	Price EUR
with swivelling heating element in the pan		688355	
Dimensions (LxDxH):	600 x 838 x 320 mm	Direct heat emission:	1,44 kW
Load:	2 x 8,0 (16,0) kW 400 V 3N	Latent heat emission:	11,20 kW
		Steam emission:	16,48 kg / h

☞ Control elements one-sided

Pan dimension: 220 x 340 x 190 mm each

Pan capacity: 8.5l - 11 l max. each

Temperature: 103 - 180°C

- Accessories included:
- 1 x Appliance connection (690457)
 - 2 x Deep fat frying basket (271586)
 - 2 x Cover
 - 2 x Bread crumbs sieve
 - 2 x Handle for swivel fixture
 - 2 x Safety drainage valve

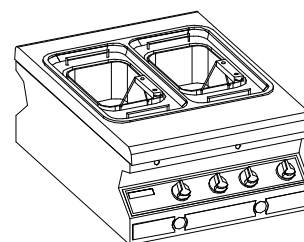

☞ When choosing the version with adapter board for thermal components and work tops, additional handles for swivel fixture have to be ordered / Cf. accessories.

Dual-Pan Deep Fat Fryer with electronic control Plus		Art. No.	Price EUR
Swivelling heating elements in the pans		891994	
Dimensions (LxDxH):	600 x 838 x 320 mm	Direct heat emission:	1,44 kW
Connected load:	2 x 8,0 (16,0) kW 400 V 3 50/60 Hz	Latent heat emission:	11,20 kW
		Steam emission:	16,48 kg / h

☞ Control elements one-sided

Pan dimension: 220 x 340 x 190 mm each

Pan capacity: 8.5 Litres - 11 Litres max.

Range of temperature: 50 - 190°C

- Accessories included:
- 1 x Appliance connection (690457)
 - 2 x Deep fat frying basket (271586)
 - 2 x Cover
 - 2 x Bread crumbs sieve
 - 2 x Handle for swivel fixture
 - 2 x Safety drainage valve

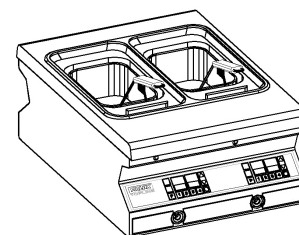

☞ When choosing the version with adapter board for thermal components and work tops, additional handles for swivel fixture have to be ordered/ Cf. accessories.

Dual-Pan Deep Fat Fryer with electronic control Plus and filter system		Art. No.	Price EUR
Swivelling heating elements in the pans		891995	
Dimensions (LxDxH):	600 x 838 x 750 / 900 mm	Direct heat emission:	1,44 kW
Connected load:	2 x 8,0 (16,0) kW 400 V 3 50/60 Hz	Latent heat emission:	11,20 kW
		Steam emission:	16,48 kg / h

☞ Control elements one-sided

Pan dimension: 220 x 340 x 190 mm each
 Pan capacity: 8.5 Litres - 11 Litres max.
 Range of temperature: 50 - 190°C
 Base cabinet in hygienic version H2,
 closed on all sides with folding door (door hinging right)

Accessories included:

- 1 x Appliance connection (690457)
- 2 x Deep fat frying basket (271586)
- 2 x Cover
- 2 x Bread crumbs sieve
- 2 x Handle for swivel fixture
- 1 x Oil container
- 2 x Coarse and fine filter

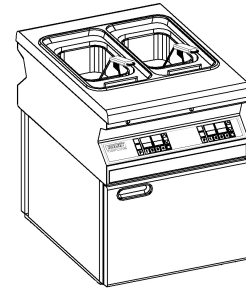

☞ When choosing the version with adapter board for thermal components and work tops, additional handles for swivel fixture have to be ordered/ Cf. accessories.

Dual-Pan Deep Fat Fryer with electronic control Plus and filter system		Art. No.	Price EUR
Swivelling heating elements in the pans		891998	
Dimensions (LxDxH):	600 x 838 x 750 / 900 mm	Direct heat emission:	1,44 kW
Connected load:	2 x 8,0 (16,0) kW 400 V 3 50/60 Hz	Latent heat emission:	11,20 kW
		Steam emission:	16,48 kg / h

Base cabinet in hygienic version H2,
 closed on all sides with folding door (door hinging left)
 Compare Art. No. 891995

☞ When choosing the version with adapter board for thermal components and work tops, additional handles for swivel fixture have to be ordered/ Cf. accessories.

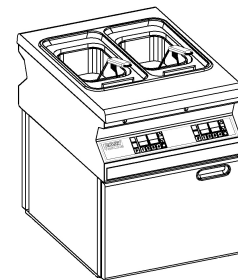

Dual-Pan Deep Fat Fryer with electronic control Plus, filter system and oil pump		Art. No.	Price EUR
Swivelling heating elements in the pans		891999	
Dimensions (LxDxH):	600 x 838 x 750 / 900 mm	Direct heat emission:	1,44 kW
Connected load:	2 x 8,0 (16,0) kW 400 V 3 50/60 Hz	Latent heat emission:	11,20 kW
		Steam emission:	16,48 kg / h

☞ Control elements one-sided

Pan dimension: 220 x 340 x 190 mm each

Pan capacity: 8.5 Litres - 11 Litres max.

Range of temperature: 50 - 190°C

Base cabinet in hygienic version H2,
closed on all sides with folding door (door hinging right)

- Accessories included:
- 1 x Appliance connection (690457)
 - 2 x Deep fat frying basket (271586)
 - 2 x Cover
 - 2 x Bread crumbs sieve
 - 2 x Handle for swivel fixture
 - 1 x Oil container
 - 2 x Coarse and fine filter
 - 1x Supply tab and hose

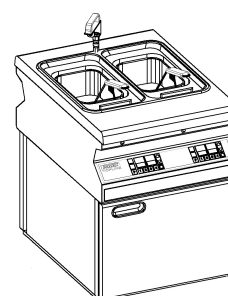

☞ When choosing the version with adapter board for thermal components and work tops, additional handles for swivel fixture have to be ordered/ Cf. accessories.

Dual-Pan Deep Fat Fryer with electronic control Plus, filter system and oil pump		Art. No.	Price EUR
Swivelling heating elements in the pans		892000	
Dimensions (LxDxH):	600 x 838 x 750 / 900 mm	Direct heat emission:	1,44 kW
Connected load:	2 x 8,0 (16,0) kW 400 V 3 50/60 Hz	Latent heat emission:	11,20 kW
		Steam emission:	16,48 kg / h

Base cabinet in hygienic version H2,
closed on all sides with folding door (door hinging left)

Compare Art. No. 891999

☞ When choosing the version with adapter board for thermal components and work tops, additional handles for swivel fixture have to be ordered/ Cf. accessories.

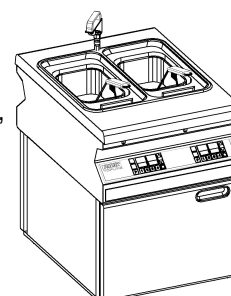

Bain Marie GN 1/1		Art. No.	Price EUR
Heated indirectly		688436	
Dimensions (LxDxH):	400 x 838 x 320 mm	Direct heat emission:	0,25 kW
Load:	2,0 kW 230 V 1N	Latent heat emission:	0,40 kW
		Steam emission:	0,59 kg / h

☞ Control elements one-sided

Pan dimension: 308 x 509 x 215 mm

Accessories included: 1 x Appliance connection (690457)
1 x Safety drainage valve

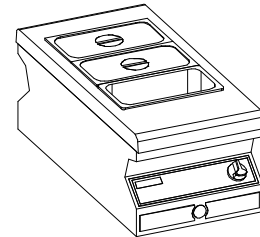

Vario Cooker GN 1/1		Art. No.	Price EUR
with swivelling flat tube heating elements		686298	
Dimensions (LxDxH):	400 x 838 x 320 mm	Direct heat emission:	0,86 kW
Load:	7,0 kW 400 V 3N	Latent heat emission:	1,40 kW
		Steam emission:	2,06 kg / h

☞ Control elements one-sided

Pan dimension: 308 x 509 x 240 mm

Pan dimension: 35 l

Accessories included: 1 x Appliance connection (6960457)
1 x Handle for swivel fixture
1 x Safety drainage valve

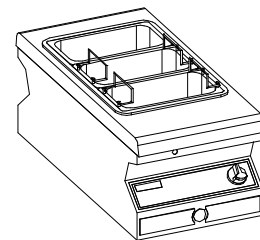

☞ When choosing the version with adapter board for thermal components and work tops, additional handles for swivel fixture have to be ordered / Cf. accessories.

Vario Cooker GN 1/1 with top-mounted electric heater		Art. No.	Price EUR
with swivelling flat tube heating elements		688428	
Dimensions (LxDxH):	400 x 838 x 320 mm	Direct heat emission:	0,95 kW
Load:	7,6 kW 400 V 3N	Latent heat emission:	1,52 kW
		Steam emission:	2,23 kg / h

☞ Control elements one-sided

Compare Art. No. 686298

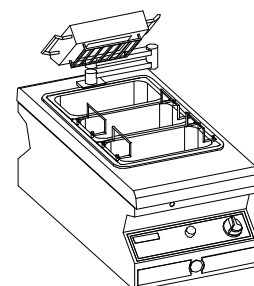

Pasta Cooker GN 1/1		Art. No.	Price EUR
Water supply and water drainage none detachable on rear		892036	
Dimensions (LxDxH):	400 x 838 x 750 / 900 mm	Direct heat emission:	0,86 kW
Connected load:	7,0 kW 400 V 3N	Latent heat emission:	1,40 kW
		Steam emission:	2,06 kg / h

☞ Control elements one-sided

Pan dimension: 308 x 509 x 240 mm
 Pan capacity: 35 Litres
 Base cabinet in hygienic version H2, closed on four sides,
 With folding door at the front (door hinging right) and
 30 mm depth compensation at the rear
 Base cabinet: 400 x 740 x 430 mm

Accessories included: 1 x Appliance connection (690457)
 1x Perforated insert (951285)
 1x stainless steel starch separator (889380)
 1x Drip plate (951250)
 1x Grid (951439)

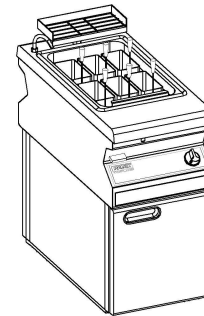

- ☞ Illustrated containers are not included in the price of devices!
- ☞ Immediately next to the pasta cooker, a base cabinet must be provided either to the left or right of it as an installation compartment for water!

Pasta Cooker GN 1/1 with 2 automatic lifting baskets		Art. No.	Price EUR
Water supply and water drainage none detachable on rear		892037	
Dimensions (LxDxH):	600 x 838 x 750 / 1120 mm	Direct heat emission:	0,86 kW
Connected load:	7,0 kW 400 V 3N	Latent heat emission:	1,40 kW
		Steam emission:	2,06 kg / h

☞ Control elements one-sided

Pan dimension: 308 x 509 x 240 mm
 Pan capacity: 35 Litres
 Operation with electronical control and digital display, start/stop button
 With 2 lifting devices right
 Base cabinet in hygienic version H2, closed on four sides,
 With folding door at the front (door hinging right) and
 30 mm depth compensation at the rear
 Base cabinet: 600 x 740 x 430 mm

Accessories included: 1x Appliance connection (690457)
 1x Perforated insert (951285)
 1x stainless steel starch separator (889380)
 4x Pasta basket (955965) 130 x 185 x 200 mm

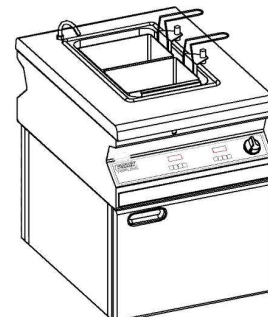

- ☞ Immediately next to the pasta cooker, a base cabinet must be provided either to the left or right of it as an installation compartment for water!

Pasta Cooker GN 1/1 with 4 automatic lifting baskets		Art. No.	Price EUR
Water supply and water drainage none detachable on rear		892038	
Dimensions (LxDxH):	600 x 838 x 750 / 1120 mm	Direct heat emission:	0,86 kW
Connected load:	7,0 kW 400 V 3N	Latent heat emission:	1,40 kW
		Steam emission:	2,06 kg / h

☞ Control elements one-sided

Pan dimension: 308 x 509 x 240 mm
 Pan capacity: 35 Litres
 Operation with electronical control and digital display, start/stop button
 With 2 lifting devices right/ 2 lifting devices left
 Base cabinet in hygienic version H2, closed on four sides,
 With folding door at the front (door hinging right) and
 30 mm depth compensation at the rear
 Base cabinet: 600 x 740 x 430 mm

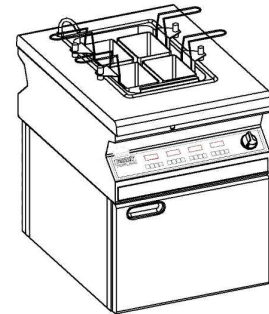

Accessories included: 1x Appliance connection (690457)
 1x Perforated insert (951285)
 1x stainless steel starch separator (889380)
 4x Pasta basket (955965) 130 x 185 x 200 mm

☞ Immediately next to the pasta cooker, a base cabinet must be provided either to the left or right of it as an installation compartment for water!

Vario Pan 400		Art. No.	Price EUR
Highly polished CNS frying / grilling top / special composition of top with vacuum-soldered copper plate		688290	
Dimensions (LxDxH):	400 x 838 x 320 mm	Direct heat emission:	1,27 kW
Load:	4,8 kW 400 V 3N	Latent heat emission:	1,54 kW
		Steam emission:	2,26 kg / h

☞ Control elements one-sided

Pan dimension: 330 x 569 x 75 mm

Pan capacity: 13 l

Cooking surface: 30 x 470 mm / 1 heating zone

Temperature: 95 - 250°C

- Accessories included:
- 1 x Appliance connection (690457)
 - 1 x GN 1/1 - Container with curved handles (607207)
 - 1 x Cover perforated (615196)
 - 1 x Drainage plug (502073)
 - 1 x Cleaning scraper (614319)

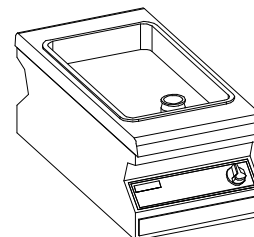

☞ Use Base cabinet of the UHVB -type!

Vario Pan 600		Art. No.	Price EUR
Highly polished CNS frying / grilling top / special composition of top with vacuum-soldered copper plate		686328	
Dimensions (LxDxH):	600 x 838 x 320 mm	Direct heat emission:	1,85 kW
Load:	7,0 kW 400 V 3N	Latent heat emission:	2,24 kW
		Steam emission:	3,29 kg / h

☞ Control elements one-sided

Pan dimension: 530 x 569 x 75 mm

Pan capacity: 21 l

Cooking surface: 530 x 470 mm / 2 heating zones (3.5 kW each)

Temperature: 95 - 250°C

- Accessories included:
- 1 x Appliance connection (690457)
 - 1 x GN 1/1 - Container with curved handles (607207)
 - 1 x Cover perforated (615196)
 - 1 x Drainage plug (502073)
 - 1 x Cleaning scraper (614319)

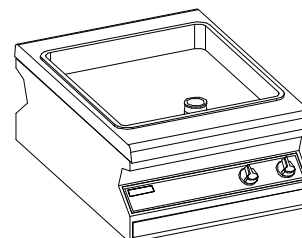

☞ Use Base cabinet of the UHVB -type!

Vario Pan 800 CC		Art. No.	Price EUR
High-gloss polished stainless steel roasting grilling top / special composition of top: sandwich designed with vacuum-soldered copper core		892039	
Dimensions (LxDxH):	800 x 838 x 320 mm	Direct heat emission:	2,77 kW
Connected load:	10,5 kW 400 V 3N	Latent heat emission:	3,36 kW
		Steam emission:	4,93 kg / h

☞ Control elements one-sided

Pan dimension: 680 x 580 x 75 mm
 Pan capacity: 29 Litres
 Cooking surface: 680 x 480 mm
 Heating zones: 3x 3,5 kW
 Range of temperature: 95 - 250°C

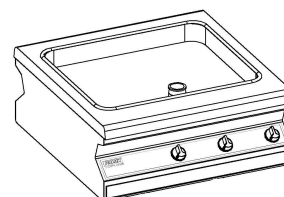

Accessories included: 1 x Appliance connection (690457)
 1 x GN 1/1 - Container 200 mm deep, with curved handles (607207)
 1 x Perforated lid (615196)
 1 x Drain plug (502073)
 1 x Cleaning scraper (614319)

☞ Use base cabinets of UHVB-type !

Vario Pan 800 SC		Art. No.	Price EUR
High-gloss polished stainless steel roasting grilling top / special composition of top: sandwich designed with vacuum-soldered steel core		892040	
Dimensions (LxDxH):	800 x 838 x 320 mm	Direct heat emission:	2,77 kW
Connected load:	10,5 kW 400 V 3N	Latent heat emission:	3,36 kW
		Steam emission:	4,93 kg / h

☞ Control elements one-sided

Pan dimension: 680 x 580 x 75 mm
 Pan capacity: 29 Litres
 Cooking surface: 680 x 480 mm
 Heating zones: 3x 3,5 kW
 Range of temperature: 95 - 250°C

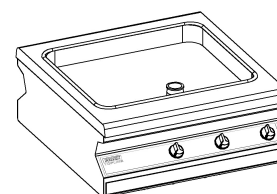

Accessories included: 1 x Appliance connection (690457)
 1 x GN 1/1 - Container 200 mm deep, with curved handles (607207)
 1 x Perforated lid (615196)
 1 x Drain plug (502073)
 1 x Cleaning scraper (614319)

☞ Use base cabinets of UHVB-type !

Vario Grill Pan		Art. No.	Price EUR
			730718
Dimensions (LxDxH):	600 x 838 x 320 mm	Direct heat emission:	3,30 kW
Connected load:	10,0 kW 400 V 3N	Latent heat emission:	4,00 kW
		Steam emission:	5,88 kg / h

☞ Control elements one-sided

Pan contents: 21 l.

Grilling surface: 530 x 465 mm / 2 heating zones (5.0 kW each)

Temperature: 100-250 °C

- Accessories included:
- 1 x Appliance connection (690457)
 - 1 x GN 1/1 - Container 200 mm deep with curved handles (607207)
 - 1 x Cover perforated (615196)
 - 1 x Drainage plug (502073)
 - 1 x Cleaning brush (614319)
 - 1 x Cleaning scraper (727563)

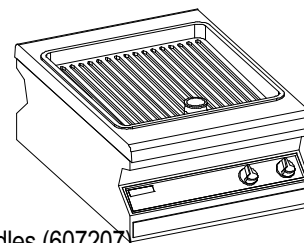

☞ Use Base cabinet of the UHVB -type !

Vario Pan M		Art. No.	Price EUR
		with base cabinet in hygienic version H2	
Dimensions (LxDxH):	600 x 838 x 750 / 820mm	Direct heat emission:	2,64 kW
Connected load:	10,0 kW 400 V 3N	Latent heat emission:	3,20 kW
		Steam emission:	4,70 kg / h

☞ Control elements one-sided

Pan dimension: 530 x 569 x 150 mm

Pan capacity: 40 Litres

Grilling surface: 530 x 470 mm

Heating zones: 2x 5.0 kW

Range of temperature: 95 - 250 °C

Base cabinet: hygienic version H2 (600 x 710 x 430 mm) and 30 mm depth compensation

Incl. water supply

- Accessories included:
- 1 x Appliance connection (690457)
 - 1 x Drain plug, 170 mm high (337684)
 - 1 x GN 1/1 - container 200 mm deep with curved handles (607207)
 - 1 x Perforated lid (615196)
 - 1 x Cleaning brush (614319)
 - 1 x Sieve (346802)

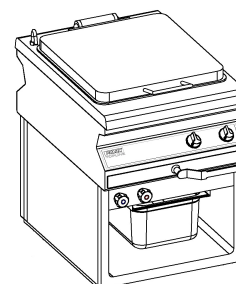

Vario Pan Plus GN 2/1 U		Art. No.	Price EUR
Open base unit		892043	
Dimensions (LxDxH):	800 x 838 x 750 / 807 mm	Direct heat emission:	3,56 kW
Connected load:	13,5 kW 400 V 3N	Latent heat emission:	4,32 kW
		Steam emission:	6,35 kg / h

☞ Control elements one-sided

- Pan dimensions: 680 x 580 x 210 mm
- Pan capacity max.: 80 Litres
- Filling level max.: 60 Litres
- Depth base unit: 710 mm and 30 mm depth compensation
- Integrated water supply
- Accessories included:
 - 1 x Appliance connection (690457)
 - 1 x GN 1/1 - Container 200 mm deep with curved handles (607207)
 - 1 x Perforated lid (615196)
 - 1 x Drain plug, 170 mm high (337684)
 - 1 x Cleaning brush (614319)
 - 1 x Sieve (866180)

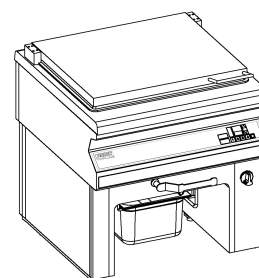

- ☞ Due to the design, the rear control panel is vertical and not in the Topline design!
- ☞ The unit must be requested with the article number #KA!

Griddle plate 400		Art. No.	Price EUR
Cooking surface made of special steel 1.2316		892044	
Dimensions (LxDxH):	400 x 838 x 320 mm	Direct heat emission:	1,58 kW
Connected load:	4,8 kW 400 V 3N	Latent heat emission:	2,68 kW
		Steam emission:	2,26 kg / h

☞ Control elements one-sided

Pan dimension: 330 x 569 x 40 mm
 Cooking surface: 330 x 470 mm
 Heating zone: 1x 4,8 kW
 Range of temperature: 95 - 250°C

Accessories included: 1 x Appliance connection (690457)
 1 x GN 1/1 - Container 200 mm deep with curved handles (607207)
 1 x Perforated lid (615196)
 1 x Drain plug (502073)
 1 x Cleaning scraper (614319)

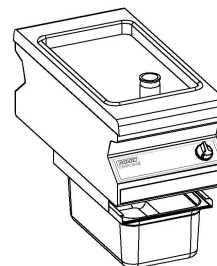

☞ Use base cabinets of UHVB-type !

Griddle Plate 600		Art. No.	Price EUR
Cooking surface made of special steel 1.2316		892045	
Dimensions (LxDxH):	600 x 838 x 320 mm	Direct heat emission:	2,31 kW
Connected load:	7,0 kW 400 V 3N	Latent heat emission:	3,91 kW
		Steam emission:	4,11 kg / h

☞ Control elements one-sided

Pan dimension: 530 x 569 x 40 mm
 Cooking surface: 530 x 470 mm
 Heating zones: 2x 3.5 kW
 Range of temperature: 95 - 250°C

Accessories included: 1 x Appliance connection (690457)
 1 x GN 1/1 - Container 200 mm deep, with curved handles (607207)
 1 x Perforated lid (615196)
 1 x Drain plug (502073)
 1 x Cleaning scraper (614319)

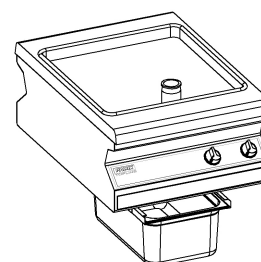

☞ Use base cabinets of UHVB-type !

Ceramic Range 1		Art. No.	Price EUR
Flush, seamless glass ceramic cool top		736422	
Dimensions (LxDxH):	400 x 838 x 320 mm	Direct heat emission:	1,40 kW
Load:	7,0 kW 400 V 3N	Latent heat emission:	0,56 kW
		Steam emission:	0,83 kg / h

☞ Control elements on both sides 1/1

Ceramic hob: 394 x 688 mm
 2 heating zones of 3.5 kW, 270 x 270 mm
 with pot detection and manual change-over switch
 Accessories included: 1 x Appliance connection (690457)

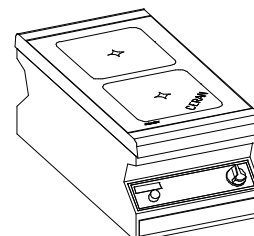

Ceramic Range 2		Art. No.	Price EUR
Flush, seamless glass ceramic cool top		736430	
Dimensions (LxDxH):	800 x 838 x 320 mm	Direct heat emission:	2,80 kW
Load:	2 x 7,0 (14,0) kW 400 V 3N	Latent heat emission:	1,12 kW
		Steam emission:	1,65 kg / h

☞ Control elements on both sides 2/2

Ceramic hob: 794 x 688 mm
 4 heating zones of 3.5 kW, 270 x 270 mm
 with pot detection and manual change-over switch
 Accessories included: 1 x Appliance connection (690457)

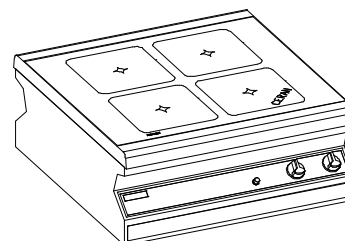

Vario Range 1 (CNS)		Art. No.	Price EUR
Flush CNS cooking / frying top		686409	
Dimensions (LxDxH):	600 x 838 x 320 mm	Direct heat emission:	1,40 kW
Load:	7,0 kW 400 V 3N	Latent heat emission:	0,56 kW
		Steam emission:	0,83 kg / h

☞ Control elements on both sides 1/1

Cooking surface: 347 x 617 mm / 2 heating zones (3.5 kW each)

All-rounded collecting channel and fat collecting drawer

Accessories included: 1 x Appliance connection (690457)

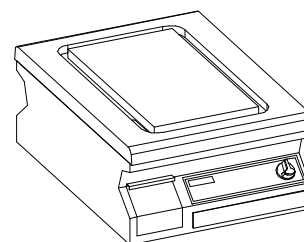

Vario Range 1 (CNS) for baking oven GN 2/1		Art. No.	Price EUR
Flush CNS cooking / frying top		709816	

Compare Art. No. 686409

Vario Range 2 (CNS)		Art. No.	Price EUR
Flush CNS cooking / frying top		688363	
Dimensions (LxDxH):	800 x 838 x 320 mm	Direct heat emission:	2,80 kW
Load:	2 x 7,0 (14,0) kW 400 V 3N	Latent heat emission:	1,12 kW
		Steam emission:	1,65 kg / h

☞ Control elements on both sides 2/2

Cooking surface: 651 x 617 mm / 4 heating zones (3.5 kW each)

All-rounded collecting channel and fat collecting drawer

Accessories included: 1 x Appliance connection (690457)

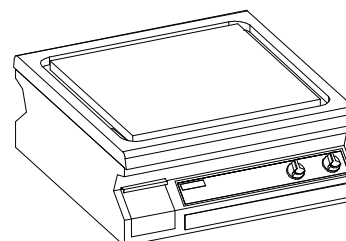

Vario Range 2 (CNS) for baking oven GN 2/1		Art. No.	Price EUR
Flush CNS cooking / frying top		709824	

Compare Art. No. 688363

Steak Grill 400 with drain on front side		Art. No.	Price EUR
Grilling directly on CNS flat heating elements for typical grill pattern		892057	
Dimensions (LxDxH):	400 x 838 x 320 mm	Direct heat emission:	1,19 kW
Connected load:	3,6 kW 230 V 1N	Latent heat emission:	1,44 kW
		Steam emission:	2,12 kg / h

☞ Control elements one-sided

Grilling surface: 290 x 410 mm
 Heating zone: 1x 3,6 kW
 Grill temperature infinitely adjustable using energy controller
 CNS flat heating elements can be swivelled upwards for cleaning the pan
 Fat collecting pan with drain plug
 Drain on front side with safety valve

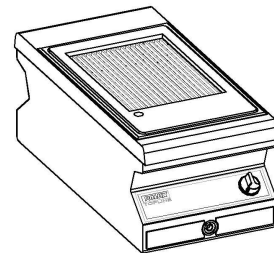

Accessories included: 1 x Appliance connection (690457)
 1 x Drain plug (869961)
 1 x Cleaning brush (864021)
 1 x Safety valve

Steak grill 400 with drain downwards		Art. No.	Price EUR
Grilling directly on CNS flat heating elements for typical grill pattern		892058	
Dimensions (LxDxH):	400 x 838 x 320 mm	Direct heat emission:	1,19 kW
Connected load:	3,6 kW 230 V 1N	Latent heat emission:	1,44 kW
		Steam emission:	2,12 kg / h

☞ Control elements one-sided

Grilling surface: 290 x 410 mm
 Heating zone: 1x 3,6 kW
 Grill temperature infinitely adjustable using energy controller
 CNS flat heating elements can be swivelled upwards for cleaning the pan
 Fat collecting pan with drain plug
 Drain downwards, 40 mm diameter

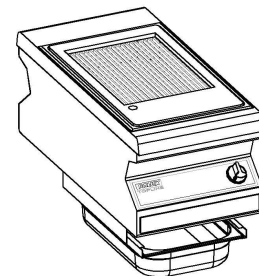

Accessories included: 1 x Appliance connection (690457)
 1 x Drain plug (869961)
 1 x Cleaning brush (864021)
 1 x GN 1/1 Container 100 mm deep, with curved handles (609773)
 1 x Perforated lid (615196)

☞ Use base cabinets of the TLGVB or UHVB-type !

Steak Grill 600 with drain on front side		Art. No.	Price EUR
Grilling directly on CNS flat heating elements for typical grill pattern		892059	
Dimensions (LxDxH):	600 x 838 x 320 mm	Direct heat emission:	1,68 kW
Connected load:	5,0 kW 400 V 3	Latent heat emission:	2,04 kW
		Steam emission:	3,00 kg / h

☞ Control elements one-sided

- Grilling surface: 490 x 410 mm
- Heating zones: 2x 2,5 kW
- Grill temperature infinitely adjustable using energy controller
- CNS flat heating elements can be swivelled upwards for cleaning the pan
- Fat collecting pan with drain plug
- Drain on front side with safety valve

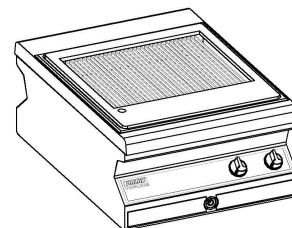

- Accessories included: 1 x Appliance connection (690457)
- 1 x Drain plug (869961)
- 1 x Cleaning brush (864021)
- 1 x Safety valve

Steak Grill 600 with drain downwards		Art. No.	Price EUR
Grilling directly on CNS flat heating elements for typical grill pattern		892060	
Dimensions (LxDxH):	600 x 838 x 320 mm	Direct heat emission:	1,68 kW
Connected load:	5,0 kW 400 V 3	Latent heat emission:	2,04 kW
		Steam emission:	3,00 kg / h

☞ Control elements one-sided

- Grilling surface: 490 x 410 mm
- Heating zones: 2x 2,5 kW
- Grill temperature infinitely adjustable using energy controller
- CNS flat heating elements can be swivelled upwards for cleaning the pan
- Fat collecting pan with drain plug
- Drain downwards, 40 mm diameter

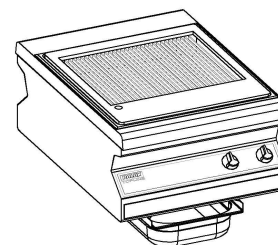

- Accessories included: 1 x Appliance connection (690457)
- 1 x Drain plug (869961)
- 1 x Cleaning brush (864021)
- 1 x GN 1/1 Container 100 mm deep, with curved handles (609773)
- 1 x Perforated lid (615196)

☞ Use base cabinets of UHVB-type !

Steak Grill 800 with drain on front side		Art. No.	Price EUR
Grilling directly on CNS flat heating elements for typical grill pattern		892061	
Dimensions (LxDxH):	800 x 838 x 320 mm	Direct heat emission:	2,82 kW
Connected load:	8,3 kW 400 V 3N	Latent heat emission:	3,43 kW
		Steam emission:	5,04 kg / h

☞ Control elements one-sided

Grilling surface: 684 x 410 mm
 Heating zones: 2
 1 x 4,7 kW
 1 x 3,6 kW

Grill temperature infinitely adjustable using energy controller
 CNS flat heating elements can be swivelled upwards for cleaning the pan
 Fat collecting pan with drain plug
 Drain on front side with safety valve

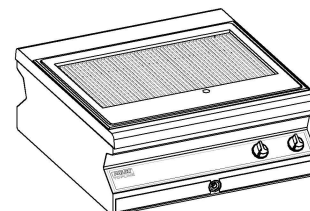

Accessories included: 1 x Appliance connection (690457)
 1 x Drain plug (869961)
 1 x Cleaning brush (864021)
 1 x Safety valve

Steak Grill 800 with drain downwards		Art. No.	Price EUR
Grilling directly on CNS flat heating elements for typical grill pattern		892062	
Dimensions (LxDxH):	800 x 838 x 320 mm	Direct heat emission:	2,82 kW
Connected load:	8,3 kW 400 V 3N	Latent heat emission:	3,43 kW
		Steam emission:	5,04 kg / h

☞ Control elements one-sided

Grilling surface: 684 x 410 mm
 Heating zones: 2
 1 x 4,7 kW
 1 x 3,6 kW

Grill temperature infinitely adjustable using energy controller
 CNS flat heating elements can be swivelled upwards for cleaning the pan
 Fat collecting pan with drain plug
 Drain downwards, 40 mm diameter

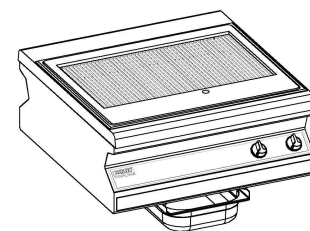

Accessories included: 1 x Appliance connection (690457)
 1 x Drain plug (869961)
 1 x Cleaning brush (864021)
 1 x GN 1/1 Container 100 mm deep, with curved handles (609773)
 1 x Perforated lid (615196)

☞ Use base cabinets of UHVB-type !

Induction Wok		Art. No.	Price EUR
Wok Pan included Ø 300 mm		877566	
Dimensions (LxDxH):	400 x 838 x 320 mm	Direct heat emission:	0,20 kW
Load:	5,0 kW 400 V 3N	Latent heat emission:	0,08 kW
		Steam emission:	0,12 kg / h

☞ Control elements one-sided

Pan content: 4.5 l
 Accessories included: 1 x Appliance connection (690457)
 1 x Wok Pan (692859)

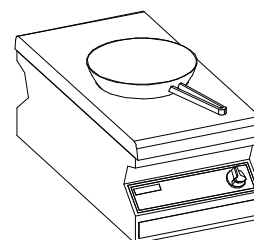

Induction Range 1		Art. No.	Price EUR
2 heating zones		877562	
Dimensions (LxDxH):	400 x 838 x 320 mm	Direct heat emission:	0,70 kW
Load:	10,0 kW 400 V 3N	Latent heat emission:	0,28 kW
		Steam emission:	0,41 kg / h

☞ Control elements on both sides 1/1

Ceramic hob: 394 x 688 mm
 2 heating zones 5.0 kW each / Dimension of coils: Ø 270 mm
 Accessories included: 1 x Appliance connection (690457)

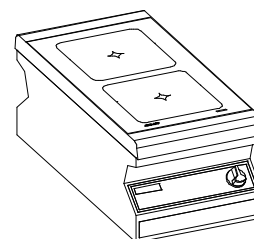

Induction Range 2		Art. No.	Price EUR
4 heating zones F		877563	
Dimensions (LxDxH):	400 x 838 x 320 mm	Direct heat emission:	0,98 kW
Load:	14,0 kW 400 V 3N	Latent heat emission:	0,39 kW
		Steam emission:	0,58 kg / h

☞ Control elements on both sides 1/1

Ceramic hob: 394 x 688 mm
 4 heating zones (3.5 kW each) / Dimension of coils: 260 x 135 mm
 Accessories included: 1 x Appliance connection (690457)

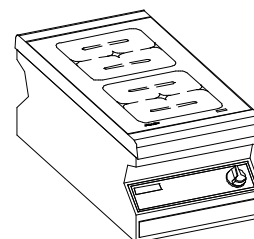

Induction Range 3		Art. No.	Price EUR
4 heating zones		877564	
Dimensions (LxDxH):	800 x 838 x 320 mm	Direct heat emission:	1,40 kW
Load:	20,0 kW 400 V 3N	Latent heat emission:	0,56 kW
		Steam emission:	0,83 kg / h

☞ Control elements on both sides 2/2

Ceramic hob: 794 x 688 mm
 4 heating zones (5.0 kW each) / Dimension of coils: Ø 270 mm
 Accessories included: 1 x Appliance connection (690457)

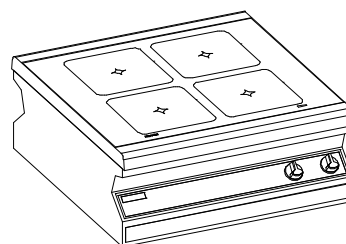

Induction Range 4		Art. No.	Price EUR
2 / 4 heating zones F		877565	
Dimensions (LxDxH):	800 x 838 x 320 mm	Direct heat emission:	1,68 kW
Load:	1 x 10,0 + 1 x 14,0 (24,0) kW 400 V 3N	Latent heat emission:	0,67 kW
		Steam emission:	0,99 kg / h

☞ Control elements on both sides 2/2

Ceramic hob: 794 x 688 mm
 2 heating zones (5.0 kW each) / Dimension of coils: Ø 270 mm
 4 heating zones (3.5 kW each) / Dimension of coils: 260 x 135 mm
 Accessories included: 1 x Appliance connection (690457)

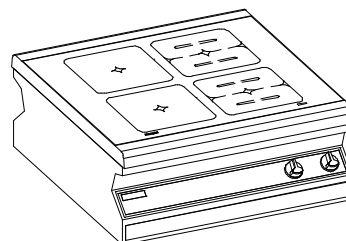

Electronic Baking Oven GN 2/1		Art. No.	Price EUR
as base cabinet		730416	
Dimensions (LxDxH):	800 x 810 x 430 mm	Direct heat emission:	1,89 kW
Load:	5,4 kW 400 V 3N	Latent heat emission:	0,86 kW
		Steam emission:	1,27 kg / h

☞ Control elements one-sided / doors on both sides

Dimension of oven: 535 x 670 x 250 mm
 Accessories included: 1 x enamelled baking tray GN 2/1 (649724)
 1 x stainless steel grate GN 2/1 (281182)

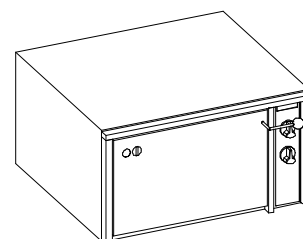

- ☞ It is possible to use a baking oven underneath any kind of range or work top.
- ☞ An electrical installation cabinet is necessary on both sides of the baking oven.

Gas Lava Stone Grill 600		Art. No	Price EUR
Grid made of stainless steel rods, CE Id.-Nr. 0085 BR0418		892047	
Dimensions (LxDxH):	600 x 838 x 750 / 900 mm	Direct heat emission:	3,61 kW
Load:	10,3 kW natural gas E	Latent heat emission:	4,12 kW
		Steam emission:	6,06 kg / h

☞ Control elements one-sided

Grilling surface: 480 x425 mm
 Heating zones: 2x 5,15 kW
 Base cabinet: H2 hygienic base (600 x 740 x 430 mm)
 Removable grease trap/water drawer

Accessories included: 1 x Appliance connection (690457)

☞ Nozzle kit for natural gas LL has to be ordered separately if required (no extra charge).

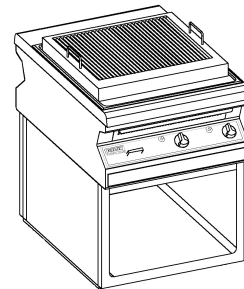

Gas Lava Stone Grill 800		Art. No	Price EUR
Grid made of stainless steel rods, CE Id.-Nr. 0085 BR0418		892056	
Dimensions (LxDxH):	800 x 838 x 750 / 900 mm	Direct heat emission:	5,42 kW
Load:	15,4 kW natural gas E	Latent heat emission:	6,18 kW
		Steam emission:	9,09 kg / h

☞ Control elements one-sided

Grilling surface: 689 x 425 mm
 Heating zones: 3x 5,15 kW
 Base cabinet: H2 hygienic base (800 x 740 x 430 mm)
 Removable grease trap/water drawer

Accessories included: 1 x Appliance connection (690457)

☞ Nozzle kit for natural gas LL has to be ordered separately if required (no extra charge).

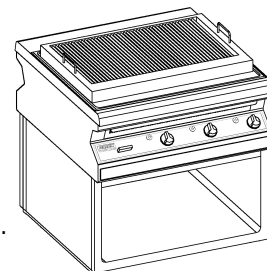

2-Burner Gas Range		Art. No.	Price EUR
With CNS sliding grill / CE Id.-Nr. 0085 CN0056		800198	
Dimensions (LxDxH):	400 x 838 x 320 mm	Direct heat emission:	3,00 kW
Load:	12,0 kW natural gas E	Latent heat emission:	1,20 kW
		Steam emission:	1,76 kg / h

☞ control elements on both sides 1/1

Cooking surface: 2 x 370 x 700 mm
 Heating zones: 1 x 5,0 kW / 1 x 7,0 kW
 Accessories included: 1 x Appliance connection (690457)

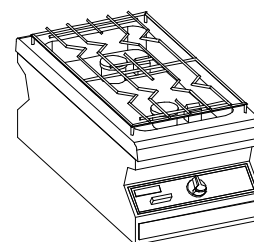

Nozzle kit for natural gas LL has to be ordered separately if required (no extra charge).

4-Burner Gas Range		Art. No.	Price EUR
With CNS sliding grill / CE Id.-Nr. 0085 CN0056		800201	
Dimensions (LxDxH):	800 x 838 x 320 mm	Direct heat emission:	6,0 kW
Load:	24,0 kW natural gas E	Latent heat emission:	2,4 kW
		Steam emission:	3,53 kg / h

☞ control elements on both sides 2/2

Cooking surface: 2 x 370 x 700 mm
 Heating zones: 2 x 5,0 kW / 2 x 7,0 kW
 Accessories included: 1 x Appliance connection (690457)

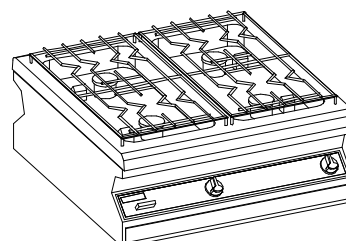

Nozzle kit for natural gas LL has to be ordered separately if required (no extra charge).

Work top	Art. No.	Price EUR
without drawer	687790	
Dimensions (LxDxH): 200 x 838 x 320 mm		

with socket with earthing contact 230 V	Art. No.	Price EUR
including installation in work top 687790	EZSD23	

with CEE-socket 400 V	Art. No.	Price EUR
including installation in work top 687790	EZCE40	

Work top with top-mounted electric heater	Art. No.	Price EUR
without drawer	702560	
Dimensions (LxDxH): 200 x 838 x 320 mm	Direct heat emission: 0,12 kW	
Load: 0,6 kW 230 V 1N	Latent heat emission: 0,18 kW	
	Steam emission: 0,24 kg / h	

Work top with drawer	Art. No.	Price EUR
Drawer (size: GN 1/1)	687804	
Dimensions (LxDxH): 400 x 838 x 320 mm		

Work top with drawer	Art. No.	Price EUR
	688401	
Dimensions (LxDxH): 600 x 838 x 320 mm		

Topline Twin-Go Black Edition in colour variation	Art. No.	Surcharge per appliance EUR
black front panel, painted graphite black RAL9011, for all thermal equipment available		
Topline Twin-Go Black Edition - Length of appliance 200 mm	TL-TW-BE-200	
Topline Twin-Go Black Edition - Length of appliance 400 mm	TL-TW-BE-400	
Topline Twin-Go Black Edition - Length of appliance 600 mm	TL-TW-BE-600	
Topline Twin-Go Black Edition - Length of appliance 800 mm	TL-TW-BE-800	
Topline operating foil silver, replacement available for all units		
change standard foil into operating foil in silver	TL-TW-SB	No surcharge
Accessories Deep Fat Fryer	Art. No.	Price EUR
Frying basket for Deep Fat Fryer Dimensions (LxDxH): 200 x 290 x 120 mm	271586	
1/2 Frying basket for Deep Fat Fryer Dimensions (LxDxH): 95 x 285 x 120 mm	275166	
Portion basket for Deep Fat Fryer Dimensions (LxDxH): 180 x 120 x 120 mm	374512	
Handle for swivel fixture - Version for adapter board no extra charge / only in connection with an adapter board	655895	-
Accessories Vario Cooker	Art. No.	Price EUR
GN 1/3 container - 200 mm deep perforated on 4 sides and bottom \varnothing 4 mm, with folding handles	609935	
GN-P 1/3 container - 200 mm deep perforated \varnothing 3 mm (suitable for the preparation of rice), with folding handles	649732	
GN 1/2 container - 200 mm deep perforated on 4 sides and bottom \varnothing 4 mm, with folding handles	609862	
Pasta basket, round \varnothing 170 mm	628042	
Pasta basket, round \varnothing 135 mm	628050	
Sieve, perforated, GN 1/1 with handles	648019	
Compartment insert for 6 compartments	930695	
Handle for swivel fixture - Version for adapter board no extra charge / only in connection with an adapter board	655899	-
Accessories Vario Range	Art. No.	Price EUR
Splash guard for Vario Range 600	690503	
Splash guard for Vario Range 800	690511	

Accessories Induction Wok	Art. No.	Price EUR
Wok Pan Ø 295 mm (included as standard equipment)	692859	
Accessories Vario Pan and griddle plate	Art. No.	Price EUR
GN 1/1 container - 200 mm deep with folding handles	607207	
Cover for GN 1/1 container with cut-out for GN 1/3 container	615196	
GN-P 1/3 container - 150 mm deep perforated (GN collecting container)	628565	
GN-P 1/3 container - 200 mm deep perforated (GN collecting container)	628573	
Cover for Vario Pan 400 and griddle plate 400	502685	
Cover for Vario Pan 600 and griddle plate 600	502693	
Cover for Vario Pan 800	892563	
Care emulsion	883277	
Splash guard for Vario Pan 400 and griddle plate 400	628085	
Splash guard for Vario Pan 600, griddle plate 600 and Grill Pan	628093	
Splash guard for Vario Pan 800	881111	
Cleaning brush	614319	
Spatula	647187	
 <p>Illustration Spatula (Art. No. 647187)</p>		
Accessories Baking Oven	Art. No.	Price EUR
Grill GN 2/1 made of CNS	281182	
Enameled baking tray GN 2/1	649724	
Accessories Gas Units	Art. No.	Price EUR
Nozzle kit for liquid gas included	-	-
Nozzle kit for natural gas LL / for 2-burner Gas Range	699187	-
Nozzle kit for natural gas LL / for 4-burner Gas Range	699195	-
Nozzle kit for natural gas LL / for Gas Grill and Gas Lava Stone Grill	939749	-
Flexible stainless steel hose W.1.4541 DN 12, Length 2000 mm	730327	

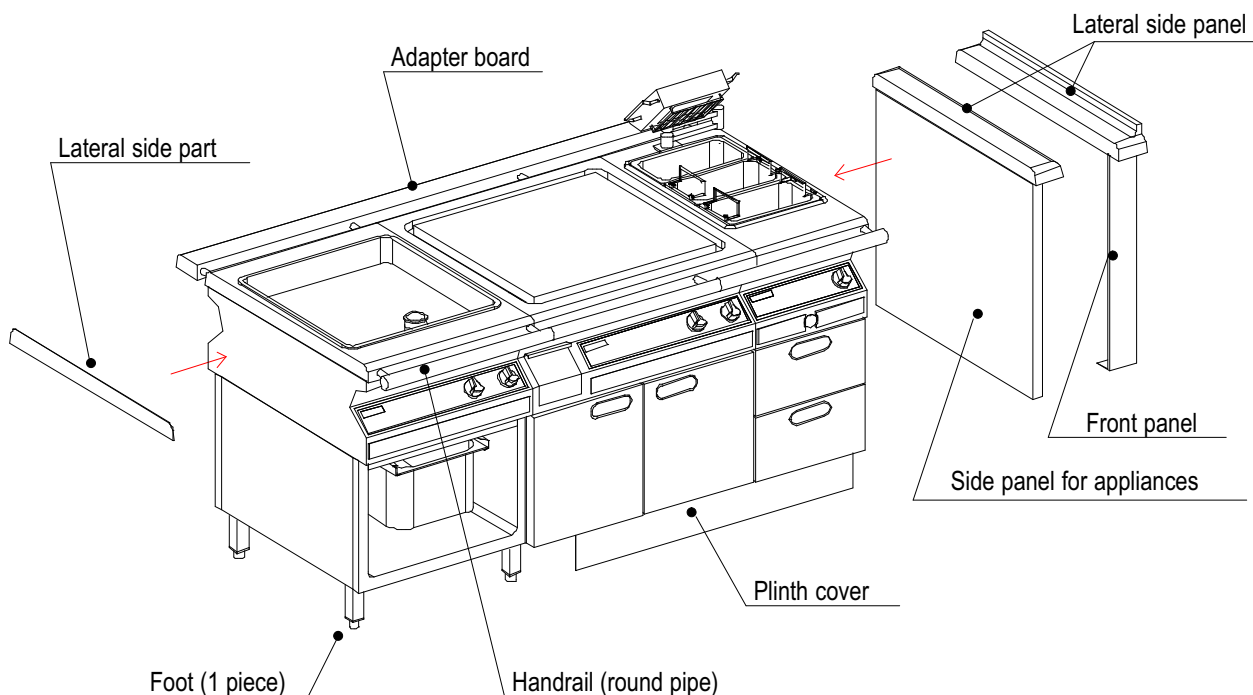

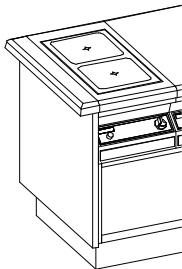
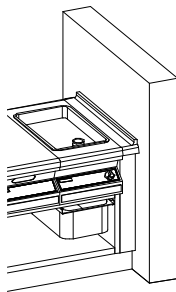
Side Panel		Art. No.	Price EUR
	Lateral side panel 100 mm radius design, folding down, appliance connection included	698636	
	Side panel for appliances Dimensions (LxDxH): 32 x 740 x 700 mm Side panel for appliances (has to be used in combination with a lateral side panel)	660671	
	Lateral side panel 100 mm radius design, folding up, appliance connection included	699381	
	Front panel Dimensions (LxDxH): 100 x 700 mm	679682	

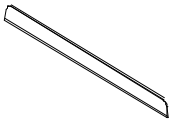
	Depth	Lateral side part	Art. No.	Price EUR
	838 mm	Lateral side part	640840	
	838 mm	Lateral side part for Ceramic and Induction Ranges	809063	
	838 mm	Lateral side part folding up, 35 mm high	878649	

Feet for Base cabinet TWG				
	Height	For depth 740 mm	Art. No.	Price EUR
	100 mm	Feet (2 pieces) on cross member for working height 850 mm	300598	
	150 mm	Feet (2 pieces) on cross member for working height 900 mm	300589	
	200 mm	Feet (2 pieces) on cross member for working height 950 mm	300605	

Foot for Base cabinet Hygiene and electric baking oven UH				
	Height	For depth 740 mm	Art. No.	Price EUR
	100 mm	Foot (1 piece) for working height 850 mm	846864	
	150 mm	Foot (1 piece) for working height 900 mm	846872	
	200 mm	Foot (1 piece) for working height 950 mm	846880	

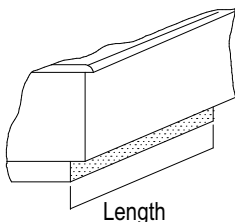
	Height	Plinth	Art. No.	Price EUR
	150 mm	Plinth panel as visual protection, made of stainless steel / installation not included	EUSK	per running metre
	150 mm	Plinth frame up to depth 800 / 838 mm Stainless steel 1,5 mm with reinforcing sections	EUSR	per running metre of the longest side

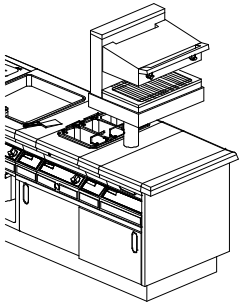
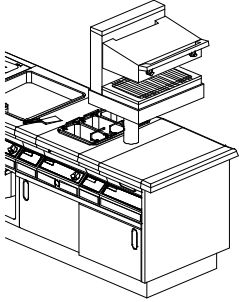
Board on column	Art. No.	Price EUR
	<p>Salamander shelf</p> <p>Dimension of board (LxDxH): 520 x 500 x 100 mm Column Ø 102 mm / Height: 400 mm Total height: 500 mm</p> <p>Placed on work top Art. No. 687790</p>	<p>ODBS50</p>
	<p>Salamander shelf - square column</p> <p>Dimension of board (LxDxH): 520 x 500 x 100 mm Square column with (LxDxH): 100 x 100 x 400 mm Total height: 500 mm</p> <p>Placed on work top Art. No. 687790</p>	<p>ODBS50-Q</p>

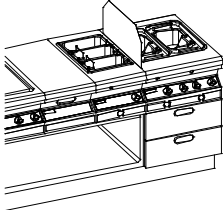
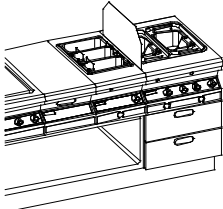
Splash guard for deep fat fryers	Art. No.	Price EUR
<p>Note for splash guard and partition wall: an installed splash guard / partition wall for deep fat fryers is according to DGUV 110-003 necessary for safety reasons if the distance between the deep fat fryer and water of any kind is less than 800 mm.</p>		
	<p>Splash guard - for mounting on worktop and wall - front with beveling</p> <p>Dimension: 2 x 650 x 350 mm</p>	<p>878661</p>
	<p>Splash guard - for mounting on worktop and wall - front with beveling</p> <p>Dimension: 2 x 750 x 350 mm</p>	<p>879236</p>

Adapter board						
Illustration	Depth 150 mm			Depth 200 mm		
	Length mm	Art. No.	Price EUR	Length mm	Art. No.	Price EUR
<p>Depth 150 mm</p> <p>Depth 200 mm</p>	400	ZAVB0415		400	ZAVB0420	
	600	ZAVB0615		600	ZAVB0620	
	800	ZAVB0815		800	ZAVB0820	
	1000	ZAVB1015		1000	ZAVB1020	
	1200	ZAVB1215		1200	ZAVB1220	
	1400	ZAVB1415		1400	ZAVB1420	
	1600	ZAVB1615		1600	ZAVB1620	
	1800	ZAVB1815		1800	ZAVB1820	
	2000	ZAVB2015		2000	ZAVB2020	
	2200	ZAVB2215		2200	ZAVB2220	
	2400	ZAVB2415		2400	ZAVB2420	
	2600	ZAVB2615		2600	ZAVB2620	
	2800	ZAVB2815		2800	ZAVB2820	
	3000	ZAVB3015		3000	ZAVB3020	
	3200	ZAVB3215		3200	ZAVB3220	
	3400	ZAVB3415		3400	ZAVB3420	
	3600	ZAVB3615		3600	ZAVB3620	

Handrail	Art. No.	Price EUR
Handrail (round pipe) Ø 40 mm / Total Length 100 mm with protective cap Basic price (up to 1000 mm in length)	ZFHLGP	
Extra charge per running metre (of more than 1000 mm in length)	ZFHLLFM	

When choosing the version with adapter board / handrail, additional handles for swivel fixture have to be ordered for Vario Cooker and Deep Fat Fryer.

Appliance connection / Side panel	Art. No.	Price EUR
Appliance connection 1 piece per unit as standard included	690457	
Side panel for wall set-up for base cabinets UH (will be delivered if required according to the installation plan)	689904	-

Support for mixer

- for installation into worktops of 200 or 400 mm Length or into central cover of 240 mm Length

Description	Art. No.	Price EUR
Support for mixer, socket and mixing tap consisting of: 1x column 150 x 150 x 250 / 740 mm 1x socket 230 V 1x bracket for mixer and cup (inclusive cup) 1x connection for mixing tap 1x KWC-one lever mixing tap 2/4" inclusive drip-stop height 490 mm spout projection 300 mm	SMS1000	
Support for mixer, socket and mixing tap consisting of: 1x column 150 x 150 x 250 / 740 mm 2x socket 230 V 2x bracket for mixer and cup (inclusive cup) 1x connection for mixing tap 1x KWC-one lever mixing tap 3/4" inclusive drip-stop height 490 mm spout projection 300 mm	SMS2000	



Illustration
Type SMS2000

- for installation into worktops of 200 or 400 mm or into central cover of 140 mm Length

Description	Art. No.	Price EUR
Support for mixer and socket consisting of: 1x column 150 x 150 x 250 mm 2x socket 230 V 2x bracket for mixer and cup (inclusive cup)	SMS3	

Description	Art. No.	Price EUR
Support for mixer for installation on upper shelf for Salamander 1x bracket for mixer and cup (inclusive cup)	MBH1	

Type			Function		Length		Corpus		Version
1	2	3	4	5	6	7	8	9	10
TWG= Base cabinet standard			IF=	Installation cabinet with folding door	02= 200 mm		<u>Depth</u>		<u>Door hinging</u>
			IB=	Installation cabinet with front panel	04= 400 mm		74= 740 mm		L= Hinged on left side
			WT=	Heated cabinet with sliding doors	06= 600 mm				R= Hinged on right side
					12= 1200 mm				B= Both sides

Type		Function		Length		Corpus	Version	
1	2	3	4	5	6	7	8	
UH= Base cabinet Hygiene		OS=	Open on both sides	04= 400 mm		<u>Depth</u>	<u>Door hinging</u>	
		FT=	Folding door(s)	06= 600 mm		4= 740 mm	L= hinged on left side	
		SB=	Drawer block	08= 800 mm				R= hinged on right side
		GN=	GN - slides	10= 1000 mm				<u>Drawer combinations</u>
		MA=	Drawer with garbage container	12= 1200 mm				1= 1 Drawer Height 200 mm
		VB=	Cabinet for Vario Pan					2= 2 Drawers Height 150/150 mm

Base cabinet as installation cabinet with folding door TWGIF

- Base cabinet as self-supporting construction, top side closed
- Closed on four sides with a double-walled folding door
- Folding door with magnetic door latch and recessed horizontal handle
- Radius upper and lower end
- Recess in the ground and cover
- Removable intermediate wall included
- Interior and exterior cabinet absolutely smooth
- Made from stainless steel 1.4301
- Height 430 mm

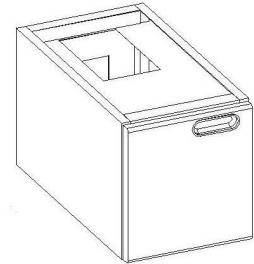

Depth 740 mm				
Length	Art. No.	Product Code	Door hinged	Price EUR
400 mm	390493	TWGIF0474L	left	
600 mm	390494	TWGIF0674L	left	
		Terminal box (Art. No. 909548) Dimensions (LxDxH): 300 x 300 x 130 mm For 9 cables Connections for energy management system For installation in installation cabinet 400 oder 600 mm length		

Base cabinet as installation cabinet with front panel TWGIB

- Base cabinet as self-supporting construction, top side closed
- Removable front panel
- On both sides with installation cut-out
- Not usable for assembly at the edge, only as intermediate element
- Made from stainless steel 1.4301
- Height 430 mm

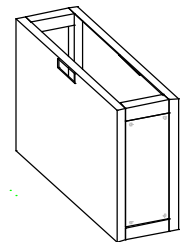

Depth 740 mm				
Length	Art. No.	Product Code	Price EUR	
200 mm	390492	TWGIB0274		
with 230 V socket for TWGIB			Art. No.	Price EUR
including installation			EZSD23	
with 400 V CEE-socket for TWGIB			Art. No.	Price EUR
including installation			EZCE40	

Base cabinet as heated cabinet with sliding doors TWGWT

- Base cabinet as self-supporting construction with insulation on sides and above
- Heated cabinet with circulating air, thermostatic temperaturecontrol up to 85°C
- Closed on four sides, double-walled sliding doors at front and rear side
- Sliding doors attached to the top, on ball bearings
- Insulated sliding doors with recessed vertical handles
- Perforated floor shelf
- Recessed operation panel on right side
- Interior and exterior cabinet absolutely smooth
- Made from stainless steel 1.4301
- Height 430 mm

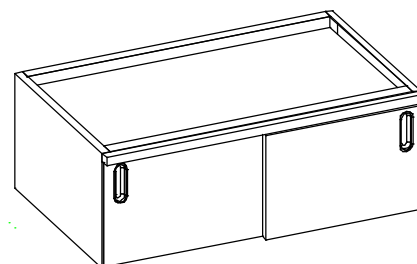

	Depth 740 mm			
Length	Art. No.	Product Code	Connected load	Price EUR
1200 mm	390650	TWGWT1274B	1,5 kW 230 V 1N	

Base cabinet Hygiene open on both sides UHOS

- Base cabinet as self-supporting structure
- Open on both sides, with even side panels and even base
- Hygienic version H2, base and side panels welded, seamless, radius R19
- Attached cover
- End of side panels double-walled when there is no base cabinet next to it
- Height 430 mm

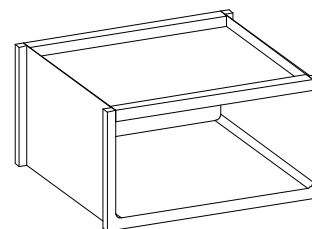

	Depth 740 mm		
Length	Art. No.	Product Code	Price EUR
400 mm	804061	UHOS044	
600 mm	804088	UHOS064	
800 mm	804096	UHOS084	
1000 mm	804118	UHOS104	
1200 mm	804126	UHOS124	

Base cabinet Hygiene with folding door(s) UHFT

- Base cabinet as self-supporting structure
- Completely closed on 4 sides, with 1 or 2 double-walled folding doors
- Door stop left or / and right
- Door with magnetic door latch
- Integrated, easy-to-clean handle recess
- Radius form (top and base)
- Hygienic version H2, base and side panels welded, seamless, radius R19
- Attached cover
- End of side panels double-walled when there is no base cabinet next to it
- Height 430 mm

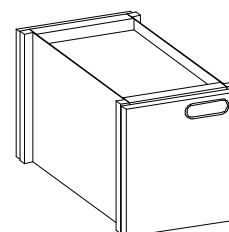

	Depth 740 mm			
Length	Art. No.	Product Code	Number of doors / door hinged	Price EUR
400 mm	804134	UHFT044LR	1 / left - right	
600 mm	804142	UHFT064LR	1 / left - right	
800 mm	804150	UHFT084	2 / left and right	

Base cabinet Hygiene with drawers UHSB

- Base cabinet as self-supporting structure
- Drawer block with removable drawers
- Drawer can be pulled out completely, rails made of stainless steel
- Integrated, easy-to-clean handle recess
- Radius form (top and base)
- Hygienic version H2, base and side panels welded, seamless, radius R19
- Attached cover
- End of side panels double-walled when there is no base cabinet next to it
- Height 430 mm

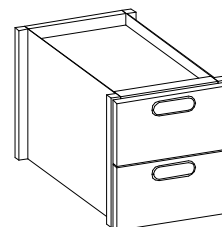

Depth 740 mm				
Length	Art. No.	Product Code	Number of drawers / height	Price EUR
400 mm	804169	UHSB0442	2 / 150 + 150 mm	
600 mm	804177	UHSB0642	2 / 150 + 150 mm	

Base cabinet Hygiene with GN slides UHGN

- Base cabinet as self-supporting structure
- Open on both sides, with even side panels and even base
- Hygienic version H2, base and side panels welded, seamless, radius R19
- rack for inserting containers and trays of size GN 1/1
- Attached cover
- End of side panels double-walled when there is no base cabinet next to it
- Height 430 mm

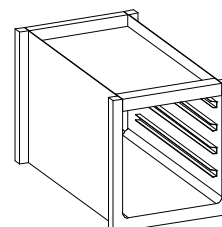

Depth 740 mm				
Length	Art. No.	Product Code	Number of drawers / height	Price EUR
400 mm	892544	UHGN044	5 / 55 mm	

Base cabinet Hygiene with garbage container UHMA

- Base cabinet as self-supporting structure
- Removable drawer as garbage container
- Drawer can be pulled out completely, rails made of stainless steel
- Integrated, easy-to-clean handle recess
- Radius form (top and base)
- Hygienic version H2, base and side panels welded, seamless, radius R19
- Attached cover
- End of side panels double-walled when there is no base cupboard next to it
- Height 430 mm

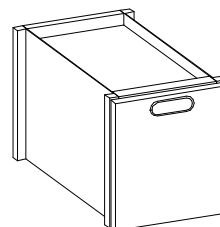

Depth 740 mm				
Length	Art. No.	Product Code	Number of plastic containers	Price EUR
400 mm	804185	UHMA044	3 pcs. (each 13.25 litres, Art. No. 892278)	

Base cabinet Hygiene for Vario Pan UHVB

- Base cabinet as self-supporting structure
- Open on both sides, with smooth side panels and smooth base
- In the base cabinet GN 1/1 insert for drainage for the Vario Pan
- On top drainage for Vario Pan
- Hygienic version H2, base and side panels welded, seamless, radius R19
- Attached cover
- End of side panels double-walled when there is no base cupboard next to it
- Height 430 mm

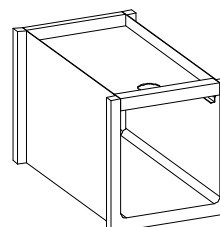

Depth 740 mm				
Length	Art. No.	Product Code	Base cabinet for	Price EUR
400 mm	809748	UHVB044	Vario pan 400	
600 mm	809756	UHVB064	Vario pan 600	
800 mm	892267	UHVB084	Vario pan 800	

Stated Dimensions Plinth Assembly

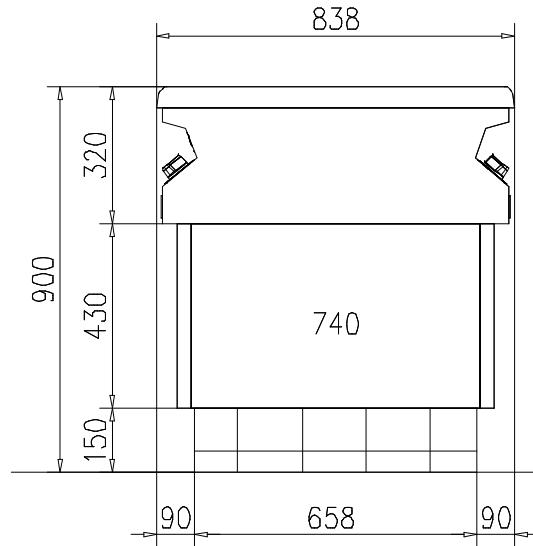

Foot - or Plinth Assembly

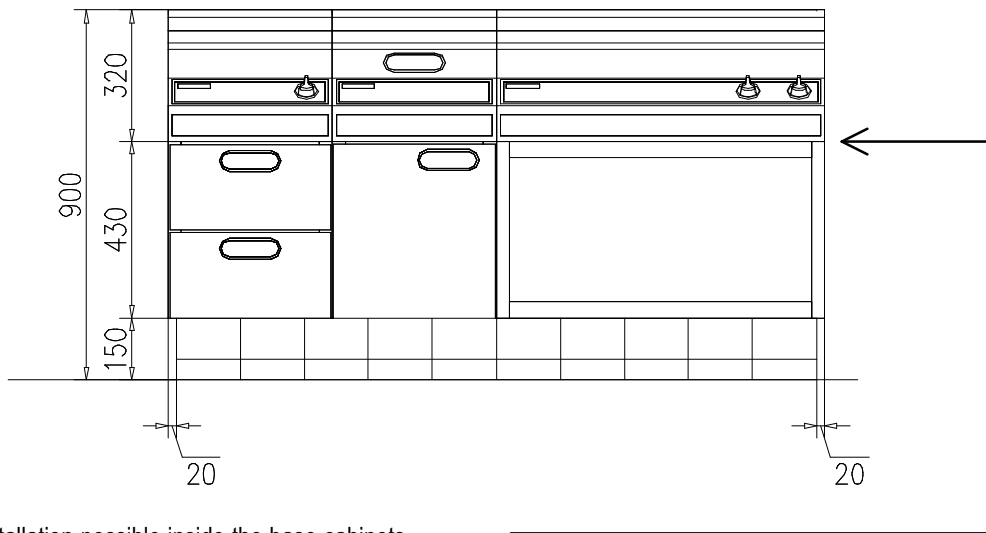

Electrical installation possible inside the base cabinets.

When choosing the version with baking oven, installation cabinets are needed on the right and on the left hand side.

Designation	Art. No.	Length	kW	Heat emission kW		Steam emission
				direct	latent	
Single-Pan Deep Fat Fryer	688339 891988 891989 891990 891992 891993	400 mm	8,0	0,72	5,60	8,24 kg/h
Dual-Pan Deep Fat Fryer	688355 891994 891995 891998 891999 892000	600 mm	2x 8,0	1,44	11,20	16,48 kg/h
Bain Marie GN 1/1	688436	400 mm	2,0	0,25	0,40	0,59 kg/h
Vario Cooker GN 1/1 with electric heater	686298 688428	400 mm	7,0 7,6	0,86 0,95	1,40 1,52	2,06 kg/h 2,23 kg/h
Pasta Cooker GN 1/1	892036	400 mm	7,0	0,86	1,40	2,06 kg/h
	892037 892038	600 mm	7,0	0,86	1,40	2,06 kg/h
Vario Pan 400	688290	400 mm	4,8	1,27	1,54	2,26 kg/h
Vario Pan 600	686328	600 mm	7,0	1,85	2,24	3,29 kg/h
Vario Pan 800 CC Vario Pan 800 SC	892039 892040	800 mm	10,5	2,77	3,36	4,93 kg/h
Vario Grill Pan	730718	600 mm	10,0	3,30	4,00	5,88 kg/h
Vario Pan M	892042	600 mm	10,0	2,64	3,20	4,70kg/h
Vario Pan Plus	892043	800 mm	13,5	3,56	4,32	6,35kg/h
Griddle plate 400	892044	400 mm	4,8	1,58	2,68	2,26 kg/h
Griddle plate 600	892045	600 mm	7,0	2,31	3,92	4,11 kg/h
Ceramic Range 1	736422	400 mm	7,0	1,40	0,56	0,83 kg/h
Ceramic Range 2	736430	800 mm	2x 7,0	2,80	1,12	1,65 kg/h

Designation	Art. No.	Length	kW	Heat emission kW		Steam emission
				direct	latent	
Vario Range 1	686409 709816	600 mm	7,0	1,40	0,56	0,83 kg/h
Vario Range 2	688363 709824	800 mm	2x 7,0	2,80	1,12	1,65 kg/h
Steak Grill 400	892057 892058	400 mm	3,6	1,19	1,44	2,12 kg/h
Steak Grill 600	892059 892060	600 mm	5,0	1,68	2,04	3,00 kg/h
Steak Grill 800	892061 892062	800 mm	8,3	2,82	3,40	5,04 kg/h
Induction Wok	877566	400 mm	5,0	0,20	0,08	0,12 kg/h
Induction Range 1	877562	400 mm	10,0	0,70	0,28	0,41 kg/h
Induction Range 2	877563	400 mm	14,0	0,98	0,39	0,58 kg/h
Induction Range 3	877564	800 mm	20,0	1,40	0,56	0,83 kg/h
Induction Range 4	877565	800 mm	10,0+14,0	1,68	0,67	0,99 kg/h
Baking Oven GN 2/1	730416	800 mm	5,4	1,89	0,86	1,27 kg/h
Gas Lava Stone Grill 600	892047	600 mm	10,3	3,61	4,12	6,06 kg/h
Gas Lava Stone Grill 800	892056	800 mm	15,4	5,42	6,18	9,09 kg/h
2-Burner Gas Range	800198	400 mm	12,0	3,00	1,20	1,76 kg/h
4-Burner Gas Range	800201	800 mm	24,0	6,00	2,40	3,53 kg/h



PALUX Aktiengesellschaft
Wilhelm-Frank-Straße 36
97980 Bad Mergentheim
GERMANY
Telephone: +49 7931 55 0
Telefax: +49 7931 55 88600
Internet: www.palux.de
E-Mail: info@palux.de
Art. No. 700797 / 26.01.2023

PALUX

Das große Freiheit