

PALUX Maître

Price-list

Prices valid from 1st February 2023

All indicated prices are list prices and are valid for a delivery within 6 weeks after placement of the order. If delivery has to be made later than 6 weeks after placement of the order, the prices will be adjusted according to the then valid price-list. All prices are per item. Our terms of delivery are: EXW Bad Mergentheim (according to Incoterms 2010), packing for land transport included, excluding vat. The prices mentioned in this price-list do not include installation of the appliances or VAT.

Subject to changes in power, dimensions and construction.

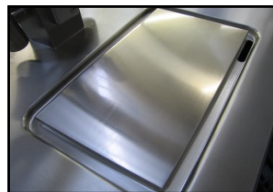

PALUX Aktiengesellschaft
Wilhelm-Frank-Straße 36
97980 Bad Mergentheim
GERMANY
Tel.: +49 (0) 7931 55-0
Fax: +49 (0) 7931 55-88600
Internet: www.palux.de
E-mail: info@palux.de

PALUX

Die große Freiheit

PALUX Maître

Contents		Page
Planning notes	from	3
Planning Tool	from	4
Worktop	from	5
Units	from	6
Accessories and Options	from	21
Heated Cabinets Standard	from	24
Cabinets Standard	from	28
Cabinets Hygiene H2	from	39
Scale drawings	from	52



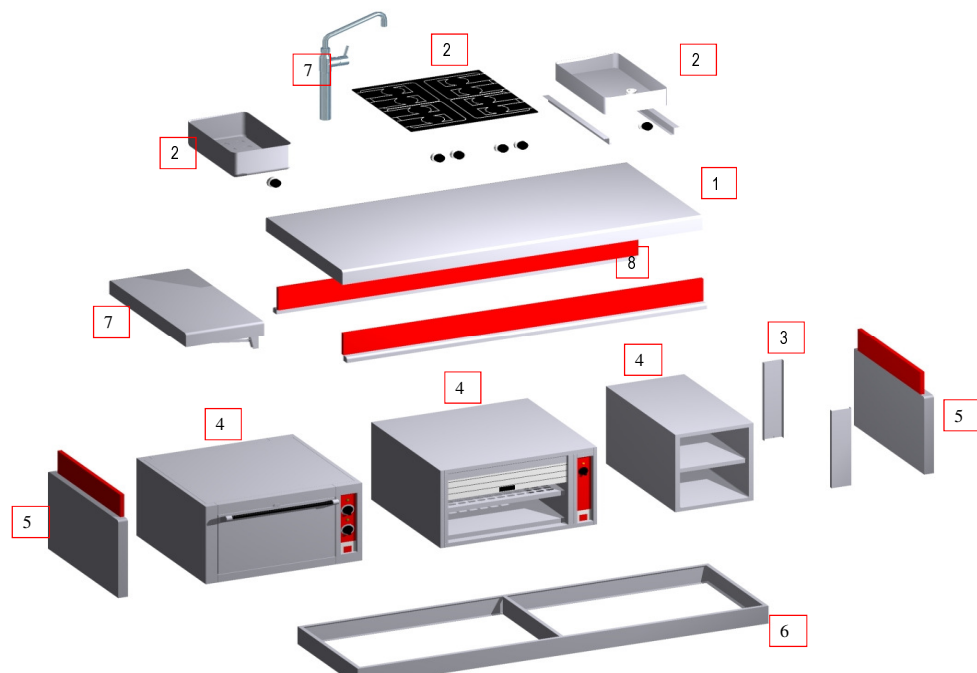

Planning Tool - Important Requirements

- The length of the work top (item 1) respectively the length of the range is the result of the summary of the dimensions of the elements (items 2) recommended (measures L1/L2/D) in the planning tool.
- The maximum length of a range is 5.200 mm because of manufacturing reasons. It is possible to weld together longer ranges on site.
- The operation panel below the work top is standardized executed as stainless steel panel (item 8). The operation panel can be lacquered in various RAL – colors. A individual design of the side walls is possible. Contact us for your ideas, please.
- For the electrical installation base cabinet of 200, 300 or 400 mm length with space for 6, 10 or 14 connections must be included in the design
- The electric connection box as well as the other energy connections to be implemented in the installation base cabinet which should have access through the side panel or through a removable installation panel on the front side. Installation base cabinets of water, gas and electricity should be separated from each other (own base cabinet for each) .
- Base cabinets (item 4) can be chosen from the "Standard" base cabinet, or the "Hygiene H2" base cabinet. A wide range of heated cabinets are also available.
- The induction generators can be installed either in the base cabinets (PALUX Generator base cabinets) or somewhere externally. It is not possible, to arrange Generator base cabinets crosswise, due to the cooling ventilation air flow. Standard length of the connection cable is 2.5 m. As option is an extended cable available to install the generators outside of the range (e. g. cellar). Maximum allowed distance from the Generator to the range is 4.0 m. Longer distances to be approved individually. External generators are not available for Induction Griddles.
- Below a Vario Pan, Steakgrill or under a Hot Plate an open base cabinet is necessary due to drainage system (Base for the planning are the measurement of the modules indicated in the Planning Tool)
- Also for Deep Fat Fryers and Pasta Cookers special base cabinets with wing doors are required (item 3).
- Bain-Maries in base cabinets must equipped with a 150 mm operation panel in the base (item 3), which fit to the operation of the drain valve.
- The side panels (item 5) are covering the base functions on the left and right hand side and to be calculated separately.
- The length of a stainless steel plinth (item 6) has to be calculated per metre of length of the range.
- Accessories as for mixer support, mixing taps, sockets (item 7) are listed in the chapter options and accessories.

Planning tool



PALUX Maître operable on both sides

example of calculation





Constructio Pos.	Description	Item code	connection values		List price in €
			Electric kW	Gas kW	
	Introduction	PM001			
Worktop (273 mm)	1 cover top 2.500 x 1.000 mm	VP731217			€
	1.01 Operation Panel In Customized RAL Colour (Black)	B_AL			€
	1.02 Delivery Cover Top And Bottom Separately	VP617442			€
	2 Fry Star Built-In Single Pan Deep Fat Fryer Version AE	876796	8,00		€
	3 Hot Plate 800 4 Z	958840	14,00		€
	3.01 Switch For Each Gas Cooking Zone	VP617436			€
	3.02 Switch For Each Gas Cooking Zone	VP617436			€
	4 Vario Pan 400 1Z	975443	4,80		€
	5 Mixing Tape Kwc	VP617449			€
	6 Induction 4Z Half Covered	976601	24,00		€
	6.01 Switch For Each Gas Cooking Zone	VP617436			€
	6.02 Switch For Each Gas Cooking Zone	VP617436			€
base cabinet (510 mm)	7 Side Panel 1000	VP617398			€
	8 Base Cabinet For Deep Fat Fryer 300 L for Fry Star AE	BZ400954			€
	9 Base cabinet, pass-through 800-BB	BC404766			€
	10 Base cabinet, pass-through 800-BB	BC404766			€
	11 Base cabinet 400 with compartement for 2 induction generator	892815			€
	12 Front Panel Non Removable (100 mm)	VP617420			€
	13 Front panel, removable, for installations	VP617423			€
	14 Base cabinet 300 with terminal box for installations, for 10 connections	873829			€
	15 Side Panel 1000	VP617398			€
Plinth (117 mm)	16 CNS Plinth, Height 117 mm	VP617441			€
	17 Wooden frame (2,600 x 1,100 mm) for transport of base units	2,86 VP617411			€
	Option Socket, 230 V 16 A, stainless steel colored plastic	VP617415			€
Total height 900 mm		Total	50,80	0,00	





PALUX Maître

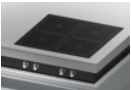





Worktop specification



Top surface 4mm (2+2). Welded reinforcement profiles of 2mm. Work top with non-drip profile. On the long sides with a radius of 15 mm. Total height of the work top is 93.5mm. Under the work top are additional construction drop in of working units. The foldable operation panel is fixed at the work top by screws.

Depth	900	1000	1100	1200	1300	1400	1500	1600	1700	1800	Depth
Length											Length
900	VP731101	VP731201	VP731301	VP731401	VP731501	VP731601	VP731701	VP731801	VP731901	VP731951	900
1000	VP731102	VP731202	VP731302	VP731402	VP731502	VP731602	VP731702	VP731802	VP731902	VP731952	1000
1100	VP731103	VP731203	VP731303	VP731403	VP731503	VP731603	VP731703	VP731803	VP731903	VP731953	1100
1200	VP731104	VP731204	VP731304	VP731404	VP731504	VP731604	VP731704	VP731804	VP731904	VP731954	1200
1300	VP731105	VP731205	VP731305	VP731405	VP731505	VP731605	VP731705	VP731805	VP731905	VP731955	1300
1400	VP731106	VP731206	VP731306	VP731406	VP731506	VP731606	VP731706	VP731806	VP731906	VP731956	1400
1500	VP731107	VP731207	VP731307	VP731407	VP731507	VP731607	VP731707	VP731807	VP731907	VP731957	1500
1600	VP731108	VP731208	VP731308	VP731408	VP731508	VP731608	VP731708	VP731808	VP731908	VP731958	1600
1700	VP731109	VP731209	VP731309	VP731409	VP731509	VP731609	VP731709	VP731809	VP731909	VP731959	1700
1800	VP731110	VP731210	VP731310	VP731410	VP731510	VP731610	VP731710	VP731810	VP731910	VP731960	1800
1900	VP731111	VP731211	VP731311	VP731411	VP731511	VP731611	VP731711	VP731811	VP731911	VP731961	1900
2000	VP731112	VP731212	VP731312	VP731412	VP731512	VP731612	VP731712	VP731812	VP731912	VP731962	2000
2100	VP731113	VP731213	VP731313	VP731413	VP731513	VP731613	VP731713	VP731813	VP731913	VP731963	2100
2200	VP731114	VP731214	VP731314	VP731414	VP731514	VP731614	VP731714	VP731814	VP731914	VP731964	2200
2300	VP731115	VP731215	VP731315	VP731415	VP731515	VP731615	VP731715	VP731815	VP731915	VP731965	2300
2400	VP731116	VP731216	VP731316	VP731416	VP731516	VP731616	VP731716	VP731816	VP731916	VP731966	2400
2500	VP731117	VP731217	VP731317	VP731417	VP731517	VP731617	VP731717	VP731817	VP731917	VP731967	2500
2600	VP731118	VP731218	VP731318	VP731418	VP731518	VP731618	VP731718	VP731818	VP731918	VP731968	2600
2700	VP731119	VP731219	VP731319	VP731419	VP731519	VP731619	VP731719	VP731819	VP731919	VP731969	2700
2800	VP731120	VP731220	VP731320	VP731420	VP731520	VP731620	VP731720	VP731820	VP731920	VP731970	2800
2900	VP731121	VP731221	VP731321	VP731421	VP731521	VP731621	VP731721	VP731821	VP731921	VP731971	2900
3000	VP731122	VP731222	VP731322	VP731422	VP731522	VP731622	VP731722	VP731822	VP731922	VP731972	3000
3100	VP731123	VP731223	VP731323	VP731423	VP731523	VP731623	VP731723	VP731823	VP731923	VP731973	3100
3200	VP731124	VP731224	VP731324	VP731424	VP731524	VP731624	VP731724	VP731824	VP731924	VP731974	3200
3300	VP731125	VP731225	VP731325	VP731425	VP731525	VP731625	VP731725	VP731825	VP731925	VP731975	3300
3400	VP731126	VP731226	VP731326	VP731426	VP731526	VP731626	VP731726	VP731826	VP731926	VP731976	3400
3500	VP731127	VP731227	VP731327	VP731427	VP731527	VP731627	VP731727	VP731827	VP731927	VP731977	3500
3600	VP731128	VP731228	VP731328	VP731428	VP731528	VP731628	VP731728	VP731828	VP731928	VP731978	3600
3700	VP731129	VP731229	VP731329	VP731429	VP731529	VP731629	VP731729	VP731829	VP731929	VP731979	3700
3800	VP731130	VP731230	VP731330	VP731430	VP731530	VP731630	VP731730	VP731830	VP731930	VP731980	3800
3900	VP731131	VP731231	VP731331	VP731431	VP731531	VP731631	VP731731	VP731831	VP731931	VP731981	3900
4000	VP731132	VP731232	VP731332	VP731432	VP731532	VP731632	VP731732	VP731832	VP731932	VP731982	4000
4100	VP731133	VP731233	VP731333	VP731433	VP731533	VP731633	VP731733	VP731833	VP731933	VP731983	4100
4200	VP731134	VP731234	VP731334	VP731434	VP731534	VP731634	VP731734	VP731834	VP731934	VP731984	4200
4300	VP731135	VP731235	VP731335	VP731435	VP731535	VP731635	VP731735	VP731835	VP731935	VP731985	4300
4400	VP731136	VP731236	VP731336	VP731436	VP731536	VP731636	VP731736	VP731836	VP731936	VP731986	4400
4500	VP731137	VP731237	VP731337	VP731437	VP731537	VP731637	VP731737	VP731837	VP731937	VP731987	4500
4600	VP731138	VP731238	VP731338	VP731438	VP731538	VP731638	VP731738	VP731838	VP731938	VP731988	4600
4700	VP731139	VP731239	VP731339	VP731439	VP731539	VP731639	VP731739	VP731839	VP731939	VP731989	4700
4800	VP731140	VP731240	VP731340	VP731440	VP731540	VP731640	VP731740	VP731840	VP731940	VP731990	4800
4900	VP731141	VP731241	VP731341	VP731441	VP731541	VP731641	VP731741	VP731841	VP731941	VP731991	4900
5000	VP731142	VP731242	VP731342	VP731442	VP731542	VP731642	VP731742	VP731842	VP731942	VP731992	5000
5100	VP731143	VP731243	VP731343	VP731443	VP731543	VP731643	VP731743	VP731843	VP731943	VP731993	5100
5200	VP731144	VP731244	VP731344	VP731444	VP731544	VP731644	VP731744	VP731844	VP731944	VP731994	5200
Length											Length
Depth	900	1000	1100	1200	1300	1400	1500	1600	1700	1800	Depth

Item code	Installation	Description	Dimension L1 / L2 / D	Power kW	Fuse A	Price €
ELECTRIC						
	976083	Ceramic Range 2Z With Pan Recognition Energy saving, electronic pot recognition Ceramic hob: 375 x 650 mm 2 heating zones 4 kW each, dimension heating zone:300 x 300 mm each. Connected load: 400V 50/60Hz 3L+N+PE	533/475/775	8,0 kW	3 x 20 A	
	976954	Ceramic Range 2Z With Pan Recognition Energy saving, electronic pot recognition Ceramic hob: 375 x 720 mm 2 heating zones 4 kW each, dimension heating zone:300 x 300 mm each. Connected load: 400V 50/60Hz 3L+N+PE	533/475/845	8,0 kW	3 x 20 A	
	976962	crosswise Ceramic Range 2Z With Pan Recognition Transversely Energy saving, electronic pot recognition Ceramic hob: 720 x 375 mm 2 heating zones 4 kW each, dimension heating zone:300 x 300 mm each Connected load: 400V 50/60Hz 3L+N+PE	878/820/500	8,0 kW	3 x 20 A	
	977004	Ceramic Range 4Z With Pan Recognition Energy saving, electronic pot recognition Ceramic hob: 720 x 650 mm 4 heating zones with 4 kW/2 x 8 kW each, heating zone 300 x 300 mm each. Connected load: 400V 50/60Hz 3L+N+PE	878/820/775	16,0 kW	2x (3x20 A)	
	977020	Ceramic Range 4Z With Pan Recognition Energy saving, electronic pot recognition Ceramic hob: 720 x 720 mm 4 heating zones with 4 kW/2 x 8 kW each, heating zone 300 x 300 mm each. Connected load: 400V 50/60Hz 3L+N+PE	878/820/845	16,0 kW	2 x (3x20 A)	
Induction						
	976350	Single Induction 1Z Ceramic hob: 360 x 360 mm 1 round coil with 5 kW, ø 270 mm Connected load: 400V 50/60Hz 3L+N+PE including 1 induction generator	518/460/485	5,0 kW	3 x 16 A	
	879708	Single Area Induction 1Z Ceramic hob: LxD 360 x 360 mm 1x 2 coils with 3,5 kW each, size of coils 260 x 135 mm Connected load: 400V 50/60Hz 3L+PE including 2 induction generators	518/460/485	7,0 kW	3 x 16 A	

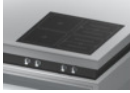
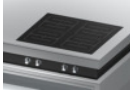

Item code	Installation	Description	Dimension L1 / L2 / D	Power kW	Fuse A	Price €
ELECTRIC						
	976393	2x Single Zone Induction Round Coil 2 x Ceramic top with 360 x 360 mm each. 2 coils with 5,0 kW each, ø 270 mm Connected load: 400V 50/60Hz 3L+N+PE including 2 induction generators	518/460/856	10,0 kW	3 x 16 A	
	976407	2 x Single Zone Area Induction 2 ceramic top with 360 x 360 mm each 2 x 2 coils with 3,5 kW each, size of coils 260 x 135 mm Connected load: 400V 50/60Hz 3L+N+PE including 4 induction generators	518/460/485	14,0 kW	3 x 20 A	
	976415	Induction 2Z Ceramic hob: LxD 375 x 650 mm 2 coils with 5,0 kW each, ø 270 mm Connected load: 400V 50/60Hz 3L+N+PE including 2 induction generators	533/475/775	10,0 kW	3 x 16 A	
	976431	Induction 2Z Ceramic hob: LxD 375 x 720 mm 2 coils with 5,0 kW each, ø 270 mm Connected load: 400V 50/60Hz 3L+N+PE including 2 induction generators	533/475/845	10,0 kW	3 x 16 A	

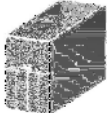

Item code	Installation	Description	Dimension L1 / L2 / D	Power kW	Fuse A	Price €
ELECTRIC						
	976474	crosswise Induction 2Z Ceramic hob: LxD 720 x 375 mm 2 coils with 5,0 kW each, ø 270 mm Connected load: 400V 50/60Hz 3L+N+PE including 2 induction generators	878/820/500	10,0 kW	3 x 16 A	
	976504	Area Induction 2Z Ceramic hob: LxD 375 x 650 mm 2 cooking areas and 4 coils with 3,5 kW each, size of coils 260 x 135 mm Connected load: 400V 50/60Hz 3L+N+PE including 4 induction generators	533/475/775	14,0 kW	3 x 20 A	
	976520	Area Induction 2Z Ceramic hob: LxD 375 x 720 mm 2 cooking areas and 4 coils with 3,5 kW each, size of coils 290 x 150 mm Connected load: 400V 50/60Hz 3L+N+PE including 4 induction generators	533/475/845	14,0 kW	3 x 20 A	
	976547	crosswise Area Induction Transversely Ceramic hob: LxD 720 x 375 mm 2 cooking zones with 4 coils with 3,5 kW each, size of coils 290 x 150 mm Connected load: 400V 50/60Hz 3L+N+PE including 4 induction generators	878/820/500	14,0 kW	3 x 20 A	
	882344	Induction 4Z Ceramic hob: LxD 500x500 mm 4 coils, 4 kW each, ø 150 mm Connected load: 400V 50/60Hz 3L+N+PE including 4 induction generators	658/600/625	16,0 kW	3 x 32 A	
	976555	Induction 4Z Ceramic hob: LxD 720 x 650 mm 4 coils with 5,0 kW each / 1 x 20,0 kW, ø 270 mm Connected load: 400V 50/60Hz 3L+N+PE including 2 induction generators	878/820/775	20,0 kW	(3x32 A)	
	976571	Induction 4Z Ceramic hob: LxD 720 x 720 mm 4 coils with 5,0 kW each / 1 x 20,0 kW, ø 270 mm Connected load: 400V 50/60Hz 3L+N+PE including 4 induction generators	878/820/845	20,0 kW	(3x32 A)	





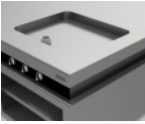
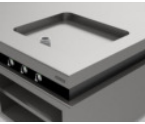

Item code	Installation	Description	Dimension L1 / L2 / D	Power kW	Fuse A	Price €
ELECTRIC						
	976601	Induction 4Z Half area induction Ceramic hob: LxD 720 x 720 mm 2 coils with 5,0 kW each / 1 x 10,0 kW, ø 270 mm 2 zones with 2 coils with 3,5 kW each / 1 x 14 kW, size of coils 290 x 150 mm Connected load: 400V 50/60Hz 3L+N+PE including 6 induction generators	878/820/845	1 x 10,0 kW 1 x 14,0 kW	3 x 16 A 3 x 20 A	
	976628	Area Induction 4Z Ceramic hob: LxD 720 x 650 mm 4 zones with 2 coils with 3,5 kW each / 2 x 14 kW, size of coils 270 x 140 mm Connected load: 400V 50/60Hz 3L+N+PE including 8 induction generators	878/820/775	2 x 14,0 kW	2 x (3x20 A)	
	976644	Area Induction 4Z Ceramic hob: LxD 720 x 720 mm 4 zones with 2 coils with 3,5 kW each / 2 x 14 kW, size of coils 290 x 150 mm Connected load: 400V 50/60Hz 3L+N+PE including 8 induction generators	878/820/845	2 x 14,0 kW	2 x (3x20 A)	

Item code	Installation	Description	Dimension L1 / L2 / D	Power kW	Fuse A	Price €
ELECTRIC						
	976652	Induction Wok 1Z Diameter ceramic wok: 302 mm 1 cooking zone with 5,0 kW <i>Accessories:</i> 1 x wok pan, ø 360 mm Connected load: 400V 50/60Hz 3L+N+PE	498/440/465	5,0 kW	3 x 16 A	
	692859	Wok-pan with handle D=360mm				
		Base Cabinets For Generator	760			
		compartment for induction generator.				
	892814	Base Cabinet For Generator 200 L x D x H: 200 x 760 x 510 mm compartment for up to 4 induction generators	GF2-U 76	200	760	
	892815	Base Cabinet For Generator 400 L x D x H: 400 x 760 x 510 mm compartment for up to 8 induction generators	GF4-U 76	400	760	
		Base Cabinet For Installations	760			
		CAUTION				
		The installation compartments / sub-distributions must not be located directly on ovens, heating cabinets or other heat sources.				
	873799	Base Cabinet For Installations 200 terminal box for installations, for 6 connections	200 x 510 mm			pcs.
	873829	Base Cabinet For Installations 300 terminal box for installations, for 10 connections	300 x 510 mm			pcs.
	887439	Base Cabinet For Installations 400 terminal box for installations, for 14 connections	400 x 510 mm			pcs.
		○ <i>Only for special export countries</i>				

Item code	Installation	Description	Dimension L1 / L2 / D	Power kW	Fuse A	Price €
ELECTRIC						
	976733	Heated Surface 1Z 1 heating zone 1,0 kW Stainless steel heated surface: LxD 375 x 650 mm Integrated into cover top Connected load: 400V 50/60Hz 2L+N+PE	533/475/775	1,0 kW	16 A	
	976741	crosswise Heated Surface 1Z 1 heating zone 1,0 kW Stainless steel heated surface: LxD 650 x 375 mm Integrated into cover top Connected load: 400V 50/60Hz 2L+N+PE	808/750/500	1,0 kW	16 A	
	976768	Heated Surface 1Z 1 heating zone 1,0 kW Stainless steel heated surface: LxD 360 x 720 mm Integrated into cover top Connected load: 400V 50/60Hz 2L+N+PE	518/460/845	1,0 kW	16 A	
	976776	crosswise Heated Surface 1Z 1 heating zone 1,0 kW Stainless steel heated surface: LxD 720 x 360 mm Integrated into cover top Connected load: 400V 50/60Hz 2L+N+PE	878/820/485	1,0 kW	16 A	
	976784	Heated Surface 2 2 heating zones 1,0 kW Stainless steel heated surface: LxD 650 x 650 mm Integrated into cover top Connected load: 400V 50/60Hz 2L+N+PE	808/750/775	2,0 kW	16 A	
	976792	Heated Surface 2Z 2 heating zones 1,0 kW Stainless steel heated surface: LxD 720 x 720 mm Integrated into cover top Connected load: 400V 50/60Hz 2L+N+PE	878/820/845	2,0 kW	16 A	
	974471	Hot Plate 600 2Z Seamless steel cooking/frying surface frying surface: LxD 347 x 617 mm with circumferential collecting channel with downwards drain in GN Container 2 heating zones with 3,5 kW each Accessories: 1 GN 1/3 – 100 mm container Connected load: 400V 50/60Hz 2L+N+PE	602/544/838	7,0 kW	2 x 16 A	
	690503	Splash guard for Hot Plate 600 2 Zones				
	975214	crosswise Hot Plate 600 2Z Seamless steel cooking/frying surface frying surface: LxD 617 x 347 mm with circumferential collecting channel with downwards drain in GN Container 2 heating zones with 3,5 kW each Accessories: 1 GN 1/3 – 100 mm container Connected load: 400V 50/60Hz 2L+N+PE	872/814/568	7,0 kW	2 x 16 A	
	884378	crosswise Splash guard for Hot Plate 600 2 Zones				
	958840	Hot Plate 800 4Z Seamless steel cooking/frying surface frying surface: LxD 651 x 617 mm with circumferential collecting channel with downwards drain in GN Container 4 heating zones with 3,5 kW each / 2 x 7,0 kW. Accessories: 1 GN 1/3 – 100 mm container Connected load: 400V 50/60Hz 2L+N+PE	906/848/838	14,0 kW	2x (2 x 16 A)	
	690511	Splash guard for Hot Plate 800 4 Zones				





Item code	Installation	Description	Dimension L1 / L2 / D	Power kW	Fuse A	Price €
ELECTRIC						
	97543	Vario Pan 400 1Z high gloss polished CNS cooking/frying area Special composition of top with vacuum soldered copper plate Dimension cooking/frying surface: 330 x 470 x 75 mm Diameter drain plug: 60 mm Pan content: 13 litres 1 heating zone with 4,8 kW Range of temperature: 95-250 °C Accessories: 1 GN 1/1 – 100 mm container with bow handles 1 perforated lid, 1 drain plug Connected load: 400V 3 N 50/60Hz	520/462/811	4,8 kW	3 x 16 A	
	502685	Lid for Vario Pan 400				
	884792	Splash guard for Vario Pan 400				
	972770	Vario Pan 600 2Z high gloss polished CNS cooking/frying area Special composition of top with vacuum soldered copper plate Dimension of cooking/frying surface: 530 x 470 x 75mm Diameter drain plug: 60 mm Special composition of top with vacuum soldered copper plate Dimension of cooking/frying surface: 530 x 470 x 75mm Diameter drain plug: 60 mm Pan content: 21 litre 2 heating zones with 3,5 kW each Range of temperature: 95 -250° C Accessories: 1 GN 1/1 – 100 mm container with bow handles 1 perforated lid GN 1/1, 1 drain plug 1 perforated lid, 1 drain plug Connected load: 400V 3 N 50/60Hz	720/662/811	7,0 kW	3 x 16 A	
	502693	Lid for Vario Pan 400				
	884802	Splash guard for Vario Pan 400				
	880234	Vario Pan 800 CC 3Z high gloss polished CNS cooking/frying area special composition of top with vacuum-soldered copper core Pan dimension: 680 x 580 x 75 mm Diameter drain plug: 60 mm Pan content: 29 litre 3 heating zones: each 3,5 kW Range of temperature: 95 - 250°C Accessories: 1 GN 1/1 - Container 100 mm deep, with curved handles 1 Perforated lid and 1 drain plug Connected load: 400V 3 N 50/60Hz	872/814/817	10,5 kW	3 x 16 A	
	892563	Lid for Vario Pan 800				
	884812	Splash guard for Vario Pan 800 CC				
	880235	Vario Pan 800 SC 3Z high gloss polished CNS cooking/frying area special composition of top with vacuum-soldered steel core Pan dimension: Diameter drain plug: 60 mm Pan content: 29 litre 3 heating zones: each 3,5 kW Range of temperature: 95 - 250°C Accessories: 1 GN 1/1 - Container 100 mm deep, with curved handles 1 Perforated lid and 1 drain plug Connected load: 400V 3 N 50/60Hz	872/814/817	10,5 kW	3 x 16 A	
	892563	Lid for Vario Pan 800				
	884812	Splash guard for Vario Pan 800 SC				

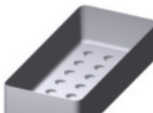
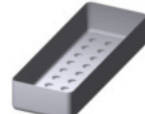
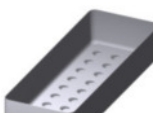



Item code	Installation	Description	Dimension L1 / L2 / D	Power kW	Fuse A	Price €
ELECTRIC						
	879767	Induction Pan 600 ZZ high polished CNS cooking surface Special composition of top with vacuum soldered copper plate Dimension of cooking/frying surface: 530 x 470 x 75 mm Diameter drain plug: 60 mm Pan content: 21 litre 2 heating zones with 4,0 kW each 2 rectangular coils, Size of coils: 205 x 418 mm Range of temperature: 80 -220°C Accessories: 1 GN 1/1 – 100 mm container with bow handles 1 perforated lid GN 1/1, 1 drain plug Connected load: 400V / 3 / 50/60Hz	719/661/766	2 x 4,0 kW	3 x 16A	
	880803	Splash guard for Induction Pan 600 including 2 induction generators				
	999999	Generator compartment for induction pan 600 ZZ L x D x H: 300 x 760 x 510 mm	GF3-U 76	300	760	on request
		CAUTION: Under a pan an open base cabinet is always to be intended for GN container.				
	882993	Pan M high polished CNS cooking surface Special composition of top with vacuum soldered copper plate Dimension of cooking/frying surface: 530 x 470 x 150 mm Diameter drain plug: 60 mm Pan content: 40 Liter 2 heating zones with 5,0 kW each Range of temperature: 95- 250 °C inclusive swivelling water intake for cold or hot water without outlet valve Accessories: 1 GN 1/1 - 200 mm container with bow handles 1 perforated lid GN 1/1, 1 drain plug Connected load: 2 x 400 V / 3 / 50/60 Hz	720/662/811	10,0 kW	3 x 16 A	
	883004	Grill pan Steel cooking surface Dimension of cooking/frying surface: 530 x 465 mm Diameter drain plug: 60 mm 2 heating zones with 5,0 kW each Range of temperature: 100 - 250 °C Accessories: 1 GN 1/1 – 100 mm container with bow handles 1 perforated lid GN 1/1, 1 drain plug Connected load: 2 x 400V 3 N 50/60 Hz 2L+N+PE	720/662/811	10,0 kW	3 x 16 A	

Item code	Installation	Description	Dimension L1 / L2 / D	Power kW	Fuse A	Price €
ELECTRIC						
	879825	Steak Grill 400 with downwards drain, drop-in unit Grilling surface: LxD 290 x 410 mm GN-Supports in base cabinet included Connected load: 230V 50/60Hz 1L+N+PE Drop-in unit with revolving anti drip moulding	542/484/748	3,6 kW	16 A	
	879826	Steak Grill 600 with downwards drain, drop-in unit Grilling surface: LxD 490 x 410 mm GN-Supports in base cabinet included Connected load: 400V 50/60Hz 2L+N+PE Drop-in unit with revolving anti drip moulding	742/684/748	5,0 kW	2 x 16 A	
	888580	Steak Grill 800 with downwards drain, drop-in unit Grilling surface: LxD 684 x 410 mm GN-Supports in base cabinet included Connected load: 400V 3N 50/60Hz 3L+N+PE Drop-in unit with revolving anti drip moulding	942/884/748	8,3 kW	3 x 16 A	
	976679	Bain-Marie GN 1/1 1Z "Standard" with built-in water tap and drain connection Pan dimension: 304 x 510 x 170 mm Accessories: 1 perforated floor shelf included Mixing tap Connected load: 230V 50/60Hz 1L+N+PE	482/424/710 686/629/520	1,8 kW	16 A	
	>>		see page			23
	976687	Bain-Marie GN 1/1 1Z "Manual" Pan dimension: 304 x 510 x 170 mm Accessories: 1 perforated floor shelf included for connection with water supply with built-in water tap and drain connection Connected load: 230V 50/60Hz 1L+N+PE	482/424/710 686/629/520	1,8 kW	16 A	
	VP617450	Supervision for Bainmarie GN 1/1 for small GN-container				
	976695	Bain-Marie GN 2/1 1Z "Standard" with built-in water tap and drain connection Pan dimension: 635 x 510 x 170 mm Accessories: 1 perforated floor shelf included Mixing tap Connected load: 230V 50/60Hz 1L+N+PE	813/755/710	3,6 kW	16 A	
	>>		see page			23
	976709	Bain-Marie GN 2/1 1Z "Manual" Pan dimension: 635 x 510 x 170 mm Accessories: 1 perforated floor shelf included for connection with water supply with built-in water tap and drain connection Connected load: 230V 50/60Hz 1L+N+PE	813/755/710	3,6 kW	16 A	
	VP617451	Supervision for Bain-Marie GN 2/1 for small GN-container				

Item code	Installation	Description	Dimension L1 / L2 / D	Power kW	Fuse A	Price €
ELECTRIC						
	884649	Bain-Marie GN 1x 2/3 1Z "Standard" with built-in water tap and drain connection Pan dimension: 304 x 334 x 170 mm 1 perforated floor shelf included <i>Mixing tap</i> Connected load: 230V 50/60Hz 1L+N+PE	482/424/534 <i>see page</i>	1,8 kW	16 A	23
	884652	Bain-Marie GN 4x 1/3 1Z "Standard" with built-in water tap and drain connection Pan dimension: 304 x 675 x 170 mm 1 perforated floor shelf included <i>Mixing tap</i> Connected load: 230V 50/60Hz 1L+N+PE	482/424/884 865/807/520 <i>see page</i>	1,8 kW <i>in crosswise</i>	16 A	23
	884653	Bain-Marie GN 4x 1/3 1Z "Manual" Pan dimension: 304 x 675 x 170 mm 1 perforated floor shelf included for connection with water Device with manually adjustable water tap and drain connection Connected load: 230V 50/60Hz 1L+N+PE	482/424/884 865/807/520	1,8 kW <i>in crosswise</i>	16 A	
	884654	Bain-Marie GN 5x 1/3 2Z "Standard" with built-in water tap and drain connection Pan dimension: 304 x 842 x 170 mm 1 perforated floor shelf included <i>Mixing tap</i> Connected load: 230V 50/60Hz 1L+N+PE	482/424/1060 1041/983/520 <i>see page</i>	3,6 kW <i>in crosswise</i>	16 A	23
	884655	Bain-Marie GN 5x 1/3 2Z "Manual" Pan dimension: 304 x 842 x 170 mm 1 perforated floor shelf included for connection with water Device with manually adjustable water tap and drain connection Connected load: 230V 50/60Hz 1L+N+PE	482/424/1060 1041/983/520	3,6 kW <i>in crosswise</i>	16 A	
	884656	Bain-Marie GN 6x 1/3 2Z "Standard" with built-in water tap and drain connection Pan dimension: 304 x 1009 x 170 mm 1 perforated floor shelf included <i>Mixing tap</i> Connected load: 230V 50/60Hz 1L+N+PE	482/424/1236 1217/1159/520 <i>see page</i>	3,6 kW <i>in crosswise</i>	16 A	23
	884657	Bain-Marie GN 6x 1/3 2Z "Manual" Pan dimension: 304 x 1009 x 170 mm 1 perforated floor shelf included for connection with water Device with manually adjustable water tap and drain connection Connected load: 230V 50/60Hz 1L+N+PE	482/424/1236 1217/1159/520	3,6 kW <i>in crosswise</i>	16 A	

Item code	Installation	Description	Dimension L1 / L2 / D	Power kW	Fuse A	Price €
ELECTRIC						
882741		Bain-Marie GN 5 x 1/6 1Z "Standard" with direct drain Pan dimension: 155 x 790 x 170/180 mm <i>Accessories:</i> 1 perforated floor shelf included >> Mixing tap Connected load: 230V 50 /60 Hz 1L+N+PE	335/277/1035	1,4 kW	16 A	23
882741*	crosswise	Bain-Marie GN 5 x 1/6 1Z "Standard" with direct drain Pan dimension: 155 x 790 x 170/180 mm <i>Accessories:</i> 1 perforated floor shelf included >> Mixing tap Connected load: 230V 50 /60 Hz 1L+N+PE	970/912/400	1,4 kW	16 A	23
882742		Bain-Marie GN 5 x 1/6 1Z "Manual" Pan dimension: 155 x 790 x 170/180 mm <i>Accessories:</i> 1 perforated floor shelf included for connection with water Device with manually adjustable water tap and drain connection Connected load: 230V 50 /60 Hz 1L+N+PE	335/277/1035	1,4 kW	16 A	
882742*	crosswise	Bain-Marie GN 5 x 1/6 1Z "Manual" Pan dimension: 155 x 790 x 170/180 mm <i>Accessories:</i> 1 perforated floor shelf included for connection with water Device with manually adjustable water tap and drain connection Connected load: 230V 50 /60 Hz 1L+N+PE	970/912/400	1,4 kW	16 A	
882743		Bain-Marie GN 6 x 1/6 1Z "Standard" with direct drain Pan dimension: 155 x 952 x 170/180 mm <i>Accessories:</i> 1 perforated floor shelf included >> Mixing tap Connected load: 230V 50 /60 Hz 1L+N+PE	335/277/1197	1,4 kW	16 A	23
882743*	crosswise	Bain-Marie GN 6 x 1/6 1Z "Standard" with direct drain Pan dimension: 155 x 952 x 170/180 mm <i>Accessories:</i> 1 perforated floor shelf included >> Mixing tap Connected load: 230V 50 /60 Hz 1L+N+PE	1132/1074/400	1,4 kW	16 A	23
882744		Bain-Marie GN 6 x 1/6 1Z "Manual" Pan dimension: 155 x 952 x 170/180 mm <i>Accessories:</i> 1 perforated floor shelf included for connection with water Device with manually adjustable water tap and drain connection Connected load: 230V 50 /60 Hz 1L+N+PE	335/277/1197	1,4 kW	16 A	
882744*	crosswise	Bain-Marie GN 5 x 1/6 1Z "Manual" Pan dimension: 155 x 790 x 170/180 mm <i>Accessories:</i> 1 perforated floor shelf included for connection with water Device with manually adjustable water tap and drain connection Connected load: 230V 50 /60 Hz 1L+N+PE	1132/1074/400	1,4 kW	16 A	

Item code	Installation	Description	Dimension L1 / L2 / D	Power kW	Fuse A	Price €
ELECTRIC						
	959723	* Vario Cooker GN 1/1 Pan content: 35 litres Pan dimension: 308 x 509 x 240 mm Connected load: 400V 50/60Hz 3L+N+PE with swivelling flat tube heating element Downwards drain Without anti drip moulding, seamlessly welded in	496/438/839	7,0 kW	3 x 16 A	
	976814	* Vario Cooker GN 1/1 With Water Supply Pan content: 35 litres Pan dimension: 308 x 509 x 240 mm Connected load: 400V 50/60Hz 3L+N+PE with swivelling flat tube heating element Downwards drain Without anti drip moulding, seamlessly welded in	496/438/839	7,0 kW	3 x 16 A	
	976822	* Vario Cooker GN 1/1 With Top-Mounted Electric Heater Pan content: 35 litres Pan dimension: 308 x 509 x 240 mm Connected load: 400V 50/60Hz 3L+N+PE with swivelling flat tube heating element Downwards drain Without anti drip moulding, seamlessly welded in	496/438/839	7,6 kW	3 x 16 A	
	975095	* Pasta Cooker GN 1/1 Pan content: 35 litres with water supply and water drainage none detachable in backside Accessories: 1 shelf, 1 overflow pipe, 1 drip tray and grate included Connected load: 400V 50/60Hz 3L+N+PE Seamlessly welded in without anti drip moulding	519/461/839 746/688/579 (Transverse installation)	7,0 kW	3 x 16 A	
	956457	Portion Single Basket With Handle 85 x 160 x 200/300 mm (max. 6 pieces)				
	977284	* Pasta Cooker GN 1/1 With 2 Automatic Basket Lifts Pan content: 35 litres with water supply and water drainage none detachable in backside with 2 basket lifts Accessories: 1 shelf, 1 overflow pipe, 1 drip tray and grate included and 2 Pasta baskets: 280x200x200 mm (953431) Connected load: 400V 50/60Hz 3L+N+PE Seamlessly welded without anti drip moulding	553/495/839 746/688/636 (Transverse installation)	7,0 kW	3 x 16 A	
	953431	Pasta basket with handle 280 x 200 x 200/300 mm (max. 2 pieces)				
		* Internal Audit to check the situation for installation at a depth <1000mm				
		Following base cabinets are compatible with the Pasta-Cooker:				
BC404920		Base cabinet with folding door 400 L - SFP4-U51-L-76-EB	see page			39
BC404921		Base cabinet with folding door 400 R - SFP4-U51-R-76-EB	see page			39
BC404922		Base cabinet with folding door 600 L - SFP6-U51-L-76-EB	see page			39
BC404923		Base cabinet with folding door 600 R - SFP6-U51-R-76-EB	see page			39
BC404924		Base cabinet with folding door 700 LR - SFP7-U51-LR-76-EB	see page			39
BZ404926		Hygiene base cabinet H2 with folding door 400 L - SFP4-U51-H2-L-76-EB	see page			49
BZ404927		Hygiene base cabinet H2 with folding door 400 R - SFP4-U51-H2-R-76-EB	see page			49
BZ404928		Hygiene base cabinet H2 with folding door 600 L - SFP6-U51-H2-L-76-EB	see page			49
BZ404929		Hygiene base cabinet H2 with folding door 600 R - SFP6-U51-H2-R-76-EB	see page			49
BZ404930		Hygiene base cabinet H2 with folding door 700 LR - SFP7-U51-H2-LR-76-EB	see page			49

Item code	Installation	Description	Dimension L1 / L2 / D	Power kW	Fuse A	Price €
ELECTRIC						
	956112	Single Pan Deep Fat Fryer, drop-in unit Useful capacity: 8,5 - 11 litre Pan dimension: 220 x 340 x 190 mm <i>Accessories:</i> 1 basket, 1 lid, 1 sieve Connected load: 400V 50/60Hz 3L+N+PE Drop-in unit with revolving anti drip moulding	542/484/748	8,0 kW	3 x 16 A	
	959596	Dual Pan Deep Fat Fryer Useful capacity: 2 x 8,5 - 11 litre Pan dimension: 220 x 340 x 190 mm (2x) <i>Accessories:</i> 2 baskets, 2 lids, 2 sieves included Connected load: 2 x 400V 50/60Hz 3L+N+PE Drop-in unit with revolving anti drip moulding	742/684/748	2 x 8,0 kW	2 x (3x16 A)	
	975117	Single Pan Deep Fat Fryer With Pump Useful capacity: 6,5 - 10 litre Pan dimension: 220 x 340 x 190 mm <i>Accessories:</i> 1 basket, 1 lid, 1 sieve included Fafoil filter system and pump in base cabinet Connected load: 400V 50/60Hz 3L+N+PE Drop-in unit with revolving anti drip moulding	542/484/748	8,0 kW	3 x 16 A	
	975125	Dual Pan Deep Fat Fryer With Pump Useful capacity: 2 x 6,5 - 10 litre Pan dimension: 220 x 340 x 190 mm (2x) <i>Accessories:</i> 2 baskets, 2 lids, 2 sieves included Fafoil filter system and pump in base cabinet Connected load: 2 x 400V 50/60Hz 3L+N+PE Drop-in unit with revolving anti drip moulding	742/684/748	2 x 8,0 kW	2 x (3x16 A)	

Following base cabinets are compatible with the deep fat fryer

BC404944	Base cabinet deep fat fryer 400 L - SFFP-U51-76-1B-L	see page	38
BC404945	Base cabinet deep fat fryer 400 R - SFFP-U51-76-1B-R	see page	38
BC404970	Base cabinet deep fat fryer 500 L - SFFP-U51-76-1B-L	see page	38
BC404971	Base cabinet deep fat fryer 500 R - SFFP-U51-76-1B-R	see page	38
BC404946	Base cabinet deep fat fryer 600 L - SFFP-U51-76-2B-L	see page	38
BC404947	Base cabinet deep fat fryer 600 R - SFFP-U51-76-2B-R	see page	38
BC404972	Base cabinet deep fat fryer 700 LR - SFFP-U51-76-2B-LR	see page	38
BZ404938	Base cabinet for deep fat fryer hygiene H2 400 L - SFFP-U51-H2-76-1B-L	see page	51
BZ404939	Base cabinet for deep fat fryer hygiene H2 400 R - SFFP-U51-H2-76-1B-R	see page	51
BZ404940	Base cabinet for deep fat fryer hygiene H2 600 L - SFFP-U51-H2-76-2B-L	see page	51
BZ404941	Base cabinet for deep fat fryer hygiene H2 600 R - SFFP-U51-H2-76-2B-R	see page	51

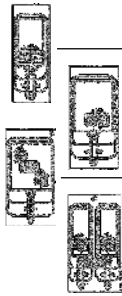

Type AE	Fry Star Typ AE	342/284/735
Type BE	Fry Star Typ BE	442/384/735
Type CE	Fry Star Typ CE	542/484/735
Type DE	Fry Star Typ DE	542/484/735

- >> Find more deep fat fryer in the Palux Fry Star price list
- >> Find more base cabinets "Standard" and base cabinets "Hygiene H2" for PALUX Fry Star on page 38 respectively page 50

Item code	Installation	Description	Dimension L1 / L2 / D	Power kW	Fuse A	Price €
GAS						
	975516	2 Burner Gas Range Gas Moulding: 350 x 650 mm 2 burners 1 x 5,0 kW & 1 x 7,0 kW Safety ignition and pilot flame included Gas range designed for natural gas E 20 mbar Nozzle kit for liquid gas 50 mbar is included Planning instructions: Gas valve of operation elements should be positioned closest to the gas connection on site	506/448/805	12,0 kW		
	976105	crosswise 2 Burner Gas Range, Transversely Gas Moulding: 650 x 350 mm 2 burners 1 x 5,0 kW & 1 x 7,0 kW Safety ignition and pilot flame included Gas range designed for natural gas E 20 mbar Nozzle kit for liquid gas 50 mbar is included Planning instructions: Gas valve of operation elements should be positioned closest to the gas connection on site	858/800/473	12,0 kW		
	975524	Gas Range 4Z <u>2 gas mouldings: 650 x 350 mm</u> 4 burners 2 x 5,0 kW & 2 x 7,0 kW Safety ignition and pilot flame included Gas range designed for natural gas E 20 mbar Nozzle kit for liquid gas 50 mbar is included Planning instructions: Gas valve of operation elements should be positioned closest to the gas connection on site Planning instructions: Gas valve of operation elements should be positioned closest to the gas connection on site	893/835/805	24,0 kW		
	882787	Gas Range 2Z Gas Moulding: 330 x 680 mm 2 Burners: in the front 10,0 kW + at the back 5,5 kW Safety ignition and pilot flame included Gas range designed for natural gas E 20 mbar Planning instructions: Gas valve of operation elements should be positioned closest to the gas connection on site Not certified for the UK market!	522/464/822	15,5 kW		
	884262	Gas Range 4Z 2 gas mouldings: 330 x 680 mm 4 burners: front left 5,5 kW, front right 10,0 kW, right rear 5,5 kW, left rear 10,0 kW Safety ignition and pilot flame included Gas range designed for natural gas E 20 mbar Planning instructions: Gas valve of operation elements should be positioned closest to the gas connection on site Not certified for the UK market!	918/860/822	31,0 kW		
	884074	Gas Hot Plate 2Z Steel cooking surface 25 mm elevated heating by 2 atmospheric burners located in front Dimension of cooking surface: 651 x 617 mm 2 heating zones with 5,0 kW each Range of temperature: 100°C to ca. 450°C Gas range designed for natural gas E 20 mbar Nozzle kit for liquid gas 50 mbar is included Planning instructions: Gas valve of operation elements should be positioned closest to the gas connection on site	802/744/803	12,0 kW		
		Accessories Gas				
	699187	Nozzle kit for natural gas LL / for 2-burner Gas Range				-
	699195	Nozzle kit for natural gas LL / for 4-burner Gas Range				-
	846805	Nozzle kit for natural gas LL / for Vario Gas Pan				-

Item code	Installation	Description	Dimension L1 / L2 / D	Power kW	Fuse A	Price €
GAS						
883650		<p>Gas Vario Pan 600 2Z high gloss polished CNS cooking/frying area Special composition of top with vacuum soldered copper plate Dimension of cooking/frying surface: 530 x 470 x 75 mm Diameter drain plug: 60 mm Pan content: 21 litre 2 heating zones with 5,0 kW each Range of temperature: 100 - 250°C Accessories: 1 GN 1/1 - 100 mm container with bow handles 1 perforated lid GN 1/1, 1 drain plug Gas range designed for natural gas E 20 mbar Nozzle kit for liquid gas 50 mbar is included Planning instructions: Gas valve of operation elements should be positioned closest to the gas connection on site</p>	720/662/794	10,0 kW		
884083		<p>Gas Lava Stone Grill Drop-in module Dimensions: 590 x 640 mm Grid made of stainless steel rods Dimension of grilling surface: 425 x 480 mm 2 heating zones with 5,15 kW each Incl. Lavastéine Gas range designed for natural gas E 20 mbar Nozzle kit for liquid gas 50 mbar is included Drop-in unit with revolving anti drip moulding Planning instructions: Gas valve of operation elements should be positioned closest to the gas connection on site</p>	742/684/720	10,3 kW		





PALUX Maître

Options and Accessories

Item code	Description	Dimension	Unit	Price €
VP617418	Cut Out In Cover Top - for installation of external equipment (VP617419)		pcs.	
VP617419	Assembly Of Foreign Units In Cover Top		pcs.	
VP617426	Cut Out Work Top L For All Sizes - for floor mounted appliance		per Cooker	
VP617423	Front Panel Removable - for installations etc.		per m	
VP617420	Front Panel Non Removable - for installations etc.		per m	
VP617424	Extension Of Bespoke Work Top		per m ²	
VP617433	Foldable Work Top designed liked cover top (max. length 500 mm)		per m ²	
AEOFL	Preparation for connecting to energy optimization Note: Energy optimization for induction units only on project-specific request.		per appliance	
VP617436	Shifting Switch to opposite side (for each Cooking Zone)		per unit	
VP617417	Shifting Switch to opposite side (for each Cooking Zone)		per unit	
BI371618	Cable Extension For Induction Coils 2 per cooking zone, up to length 4.000 mm		pcs.	
VP617397	Side Panel 900mm Depth		pcs.	
VP617398	Side Panel 1000 mm Depth		pcs.	
VP617399	Side Panel 1100 mm Depth		pcs.	
VP617400	Side Panel 1200 mm Depth		pcs.	
VP617401	Side Panel 1300 mm Depth		pcs.	
VP617402	Side Panel 1400 mm Depth		pcs.	
VP617403	Side Panel 1500 mm Depth		pcs.	
VP617404	Side Panel 1600 mm Depth		pcs.	
VP617405	Side Panel 1700 mm Depth		pcs.	
VP617406	Side Panel 1800 mm Depth		pcs.	
1H011946	Side Panel right for wall installation or transition to high substructures Length: 50 mm, Height: 548 mm		pcs.	
1H014422	Side Panel left for wall installation or transition to high substructures Length: 50 mm, Height: 548 mm		pcs.	

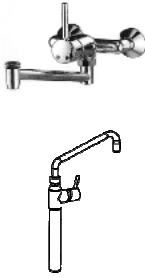

PALUX Maître

Options and Accessories

	Item code	Description	Dimension	Unit	Price €
	VP617415	Socket 230 V 16 A, stainless steel colored plastic		pcs.	
	VP617438	Euro socket type CEE 400V 16A, stainless steel colored plastic.		pcs.	
	VP617437	Euro socket type CEE 400V 32A, stainless steel colored plastic.		pcs.	
	VP617422	Plug weld connection in front		per m	
	VP617446	Wall Connection CU 100 Backsplash in material thickness 2 mm, 100 mm high, 15 mm folded over completely		per m	
	VP617441	Stainless Steel Plinth, 117 mm Height Price per metre up to a depth of 1.100 mm		per m	
	VP617441-12	Stainless Steel Plinth, 117 mm Height Price per metre from depth 1.200 mm up to 2.000 mm		per m	
	VP617411	Wooden frame for transport of base units		pro m ²	
	VP617442	Delivery in parts (Work top and base cabinets separatly)		per range	
	MDVSO12	Welding of the Maître cover sheet on site incl. preparing for a seam weld (Price without travel) till depth 1200 mm			
	MDVSO18	Welding of the Maître cover sheet on site incl. preparing for a seam weld (Price without travel) till depth 1800 mm			
	B_AL	Operation Panel laquered in customized RAL Colour RAL Colour according to costumer		pcs.	
	882745	Wall mounted Mixing T ap "Echtermann" outreach: 300 mm for mounting to shelf Connection single faucet G 3/4	200	pcs.	
	VP617449	Mixing tap KWC height 650 mm outreach: 300 mm Drip stop Connection single faucet G 3/4	100	pcs.	
	VP617448	Mixing tap KWC special height 490 mm outreach: 300 mm Drip stop Connection single faucet G 3/4	100	pcs.	

PALUX Maître

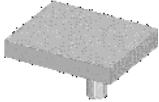
Options and Accessories

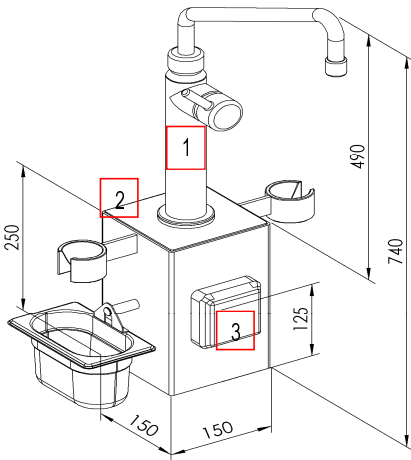
	Item code	Description	Dimension	Unit	Price €
	EOBS-M	Board board dimensions (LxDxH): 1000 x 450 x 100 mm all sides folded down 90° bottom side closed excl. ceiling suspension or round columns of round pipe (Ø =102 mm) → Boards of >2500 mm require 3 ceiling suspensions or 3 columns of round pipe Total height: 500 mm		per m	761,00
	ODBS50	Shelf for salamander board dimensions (LxDxH): 520 x 500 x 100 mm diameter of circular column 102 mm height 400 mm Total height: 500 mm		pcs.	
	ODBS50-Q	Shelf for salamander - square column board dimensions (LxDxH): 520 x 500 x 100 mm square column with (LxDxH): 100 x 100 x 400 mm Total height: 500 mm		pcs.	
	SMS1000	Column for one mixer bracket consists of: 1 x Mixing tap KWC special (Mixing tap special included VP617448) 1 column 150 x 150 x 250 mm 1 mixer bracket, 1 cup holder 1x GN1/9 container for cupholder 1 hole for socket (Socket included 230 V, VP617415)		pcs.	
	SMS2000	Column for two mixer bracket consists of: 2 x Mixing tap KWC special (Mixing tap special included, VP617448) 1x console 150x150x250mm / 740mm 2x cups for cupholder 2x GN1/9 container for cupholder 2x holes for socket (2 Sockets 230 V included, VP617415)		pcs.	
		Illustration: SMS2000			
					
		Legend: 1. Mixing faucet (Accessories/Options) 2. Console 3. Socket (Accessories/Options)			
	SMS3	Column for two mixer bracket consists of: 1x console 150 x 150 x 250mm 2x cups for cupholder 2x holes for socket (2 Sockets 230 V included, VP617415)		pcs.	
	MBH1	Support for mixer for installation on upper shelf for Salamander 1x bracket for mixer and cup (incl. cup)		pcs.	

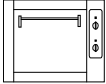
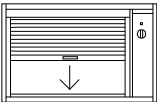
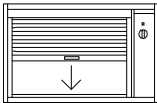

PALUX Maître

Heated Cabinets "Standard"
Standard height 510 mm

Item code	Description	Model	Length mm	Depth mm	Power kW	Abs. A	Price €
	<u>Baking oven GN with folding door</u> 1 baking sheet and 1 CrNi grate GN 2/1 included						
976830	Oven GN 2/1 with folding door on one side 1 baking sheet and 1 CrNi grate GN 2/1 included Dimension: 800 x 760 x 510 mm Inside Dimension: 540 x 680 x 270 mm Connected load: 400V 50/60Hz 3L+N+PE	BO8-U-76	800	760	5,4 kW	3 x 16 A	
976857	Oven "BM" GN 2/1-BB-86 with folding door on both sides 1 baking sheet and 1 CrNi grate GN 2/1 included Dimension: 850 x 860 x 510 mm Inside Dimension: 580 x 745 x 290 mm Connected load: 400V 50/60Hz 3L+N+PE	BO8-U 86 BB	850	860	5,6 kW	3 x 16 A	
976865	Oven "BM" GN 2/1-BB-96 with folding door on both sides 1 baking sheet and 1 CrNi grate GN 2/1 included Dimension: 850 x 960 x 510 mm Inside Dimension: 580 x 845 x 290 mm Connected load: 400V 50/60Hz 3L+N+PE	BO8-U 96 BB	850	960	5,6 kW	3 x 16 A	
976873	 Oven "BM" GN 2/1-BB-106 with folding door on both sides 1 baking sheet and 1 CrNi grate GN 2/1 included Dimension: 850 x 1060 x 510 mm Inside Dimension: 580 x 945 x 290 mm Connected load: 400V 50/60Hz 3L+N+PE	BO8-U 106 BB	850	1060	9,2 kW	3 x 20 A	
976903	 Oven "BM" GN 2/1-BB-116 with folding door on both sides 1 baking sheet and 1 CrNi grate GN 2/1 included Dimension: 850 x 1160 x 510 mm Inside Dimension: 580 x 1045 x 290 mm Connected load: 400V 50/60Hz 3L+N+PE	BO8-U 116 BB	850	1160	9,2 kW	3 x 20 A	
976911	Oven "BM" GN 2/1-BB-126 with folding door on both sides 1 baking sheet and 1 CrNi grate GN 2/1 included Dimension: 850 x 1260 x 510 mm Inside Dimension: 580 x 1145 x 290 mm Connected load: 400V 50/60Hz 3L+N+PE	BO8-U 126 BB	850	1260	11,2 kW	3 x 25 A	

PALUX Maître

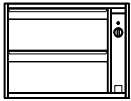
Heated Cabinets "Standard"
Standard height 510 mm

Item code	Description	Model	Length mm	Depth mm	Power kW	Abs. A	Price €
Heated Cabinet with folding door							
All cabinets are heated by circulation air							
	885519	Heated Cabinet F 500L one-sided with folding door door hinged on the left side heated by circulation air, incl. 1 storage shelf Inner dimensions: 345 x 710 x 430 mm Connected load: 230V 50/60Hz 1L+N+PE	WF5-UL 76	500	760	2,3 kW	16 A
	885520	Heated Cabinet F 500R one-sided with folding door door hinged on the right side heated by circulation air, incl. 1 storage shelf Inner dimensions: 345 x 710 x 430 mm Connected load: 230V 50/60Hz 1L+N+PE	WF5-UR 76	500	760	2,3 kW	16 A
	Heated Cabinet with vertical sliding door						
All cabinets are heated by circulation air							
	885521	Heated Cabinet R 800 one sided, with vertical sliding door heated by circulation air, incl. 1 storage shelf Inner dimensions: 645 x 710 x 395 mm Connected load: 230V 50/60Hz 1L+N+PE	WR8-U 76	800	760	2,3 kW	16 A
	885522	Heated Cabinet R 800-BB on both sides, with vertical sliding door heated by circulation air, incl. 1 storage shelf Inner dimensions: 645 x 810 x 395 mm Connected load: 230V 50/60Hz 1L+N+PE	WR8-U BB 86	800	860	2,3 kW	16 A
	885523	Heated Cabinet R 800-BB on both sides, with vertical sliding door heated by circulation air, incl. 1 storage shelf Inner dimensions: 645 x 910 x 395 mm Connected load: 230V 50/60Hz 1L+N+PE	WR8-U BB 96	800	960	2,3 kW	16 A

PALUX Maître

Heated Cabinets "Standard"
Standard height 510 mm

Item code	Description	Model	Length mm	Depth mm	Power kW	Abs. A	Price €
Heated Cabinet with vertical sliding door							
All cabinets are heated by circulation air							
885509	Heated Cabinet R 800-BB on both sides, with vertical sliding door heated by circulation air, incl. 1 storage shelf Inner dimensions: 645 x 1010 x 395 mm Connected load: 230V 50/60Hz 1L+N+PE	WR8-U BB 106	800	1060	2,3 kW	16 A	
885510	Heated Cabinet R 800-BB on both sides, with vertical sliding door heated by circulation air, incl. 1 storage shelf Inner dimensions: 645 x 1110 x 395 mm Connected load: 230V 50/60Hz 1L+N+PE	WR8-U BB 116	800	1160	2,3 kW	16 A	
885511	Heated Cabinet R 800-BB on both sides, with vertical sliding door heated by circulation air, incl. 1 storage shelf Inner dimensions: 645 x 1210 x 395 mm Connected load: 230V 50/60Hz 1L+N+PE	WR8-U BB 126	800	1260	2,3 kW	16 A	
885512	Heated Cabinet R 1000 one sided, with vertical sliding door heated by circulation air, incl. 1 storage shelf Inner dimensions: 845 x 710 x 395 mm Connected load: 230V 50/60Hz 1L+N+PE	WR10-U 76	1000	760	2,3 kW	16 A	
885514	Heated Cabinet R 1000-BB on both sides, with vertical sliding door heated by circulation air, incl. 1 storage shelf Inner dimensions: 845 x 810 x 395 mm Connected load: 230V 50/60Hz 1L+N+PE	WR10-U BB 86	1000	860	2,3 kW	16 A	
885515	Heated Cabinet R 1000-BB on both sides, with vertical sliding door heated by circulation air, incl. 1 storage shelf Inner dimensions: 845 x 910 x 395 mm Connected load: 230V 50/60Hz 1L+N+PE	WR10-U BB 96	1000	960	2,3 kW	16 A	
885516	Heated Cabinet R 1000-BB on both sides, with vertical sliding door heated by circulation air, incl. 1 storage shelf Inner dimensions: 845 x 1010 x 395 mm Connected load: 230V 50/60Hz 1L+N+PE	WR10-U BB 106	1000	1060	2,3 kW	16 A	
885517	Heated Cabinet R 1000-BB on both sides, with vertical sliding door heated by circulation air, incl. 1 storage shelf Inner dimensions: 845 x 1110 x 395 mm Connected load: 230V 50/60Hz 1L+N+PE	WR10-U BB 116	1000	1160	2,3 kW	16 A	
885518	Heated Cabinet R 1000-BB on both sides, with vertical sliding door heated by circulation air, incl. 1 storage shelf Inner dimensions: 845 x 1210 x 395 mm Connected load: 230V 50/60Hz 1L+N+PE	WR10-U BB 126	1000	1260	2,3 kW	16 A	

PALUX Maître

Heated Cabinets "Standard"
Standard height 510 mm

Item code	Description	Model	Length mm	Depth mm	Power kW	Abs. A	Price €
Heated Cabinet For Cups with drawer							
All cabinets are heated by circulation air							
885502	Heated Cabinet For Cups S 700 with 2 drawers, Heated by circulation air Inner dimensions of drawer: 510 x 580 x 160 mm Connected load: 230V 50/60Hz 1L+N+PE	TWS7-U 76	700	760	2,3 kW	16 A	
Heated Cabinets With Drawer							
All cabinets are Heated by circulation air							
885503	Heated Cabinet With Drawer 700 Heated by circulation air Inner dimensions of drawer: 2 stacks; plates with 280 mm diameter Connected load: 230V 50/60Hz 1L+N+PE	WS7-U-1S-28T-46	700	460	2,3 kW	16 A	
885504	Heated Cabinet With Drawer 800 Heated by circulation air Capacity: 2 stacks plates of 30 cm Connected load: 230V 50/60Hz 1L+N+PE	WS8-U-1S-30T-46	800	460	2,3 kW	16 A	
885505	Heated Cabinet With Drawer 900 Heated by circulation air Capacity: 2 stacks plates of 30 cm Connected load: 230V 50/60Hz 1L+N+PE	WS9-U-1S-30T-46	900	460	2,3 kW	16 A	
885506	Heated Cabinet With Drawer 700 Heated by circulation air Capacity: 3 stacks plates of 28 cm Connected load: 230V 50/60Hz 1L+N+PE	WS7-U-1S-28T-66	700	660	2,3 kW	16 A	
885507	Heated Cabinet With Drawer 800 Heated by circulation air Capacity: 4 stacks plates of 28 cm Connected load: 230V 50/60Hz 1L+N+PE	WS8-U-1S-30T-66	800	660	2,3 kW	16 A	
885508	Heated Cabinet With Drawer 900 Heated by circulation air Capacity: 4 stacks plates of 30 cm Connected load: 230V 50/60Hz 1L+N+PE	WS9-U-1S-30T-66	900	660	2,3 kW	16 A	

PALUX Maître

Base Cabinets "Standard"
Standard height 510 mm

Item code	Description	Model	Length mm	Depth mm	Price €
Base Cabinets Closed On Three Sides EB		360			
all cabinets are equipped with one shelf					
	BC404578	Base Cabinet Closed On Three Sides 400 open on one side with 1 storage shelf Dimension: 347 x 360 x 458 mm	TO4-U 36EB	400	360
	BC404565	Base Cabinet Closed On Three Sides 500 open on one side with 1 storage shelf Dimension: 447 x 360 x 458 mm	TO5-U 36EB	500	360
	BC404580	Base Cabinet Closed On Three Sides 600 open on one side with 1 storage shelf Dimension: 447 x 360 x 458 mm	TO6-U 36EB	600	360
	BC404583	Base Cabinet Closed On Three Sides 700 open on one side with 1 storage shelf Dimension: 647 x 360 x 458 mm	TO7-U 36EB	700	360
	BC404576	Base Cabinet Closed On Three Sides 800 open on one side with 1 storage shelf Dimension: 747 x 360 x 458 mm	TO8-U 36EB	800	360
	BC404581	Base Cabinet Closed On Three Sides 900 open on one side with 1 storage shelf Dimension: 847 x 360 x 458 mm	TO9-U 36EB	900	360
	BC404585	Base Cabinet Closed On Three Sides 1000 open on one side with 1 storage shelf Dimension: 947 x 360 x 458 mm	TO10-U 36EB	1000	360
	BC404589	Base Cabinet Closed On Three Sides 1100 open on one side with 1 storage shelf Dimension: 1047 x 360 x 458 mm	TO11-U 36EB	1100	360
	BC404596	Base Cabinet Closed On Three Sides 1200 open on one side with 1 storage shelf Dimension: 1147 x 360 x 458 mm	TO12-U 36EB	1200	360

PALUX Maître

Base Cabinets "Standard"
Standard height 510 mm

Item code	Description	Model	Length mm	Depth mm	Price €
Base Cabinets Closed On Three Sides EB		460			
all cabinets are equipped with one shelf					
	BC404587	Base Cabinet Closed On Three Sides 400 open on one side with 1 storage shelf Dimension: 347 x 460 x 458 mm	TO4-U 46EB	400	460
	BC404586	Base Cabinet Closed On Three Sides 500 open on one side with 1 storage shelf Dimension: 447 x 460 x 458 mm	TO5-U 46EB	500	460
	BC404591	Base Cabinet Closed On Three Sides 600 open on one side with 1 storage shelf Dimension: 447 x 460 x 458 mm	TO6-U 46EB	600	460
	BC404573	Base Cabinet Closed On Three Sides 700 open on one side with 1 storage shelf Dimension: 647 x 460 x 458 mm	TO7-U 46EB	700	460
	BC404577	Base Cabinet Closed On Three Sides 800 open on one side with 1 storage shelf Dimension: 747 x 460 x 458 mm	TO8-U 46EB	800	460
	BC404582	Base Cabinet Closed On Three Sides 900 open on one side with 1 storage shelf Dimension: 847 x 460 x 458 mm	TO9-U 46EB	900	460
	BC404586	Base Cabinet Closed On Three Sides 1000 open on one side with 1 storage shelf Dimension: 947 x 460 x 458 mm	TO10-U 46EB	1000	460
	BC404590	Base Cabinet Closed On Three Sides 1100 open on one side with 1 storage shelf Dimension: 1047 x 460 x 458 mm	TO11-U 46EB	1100	460
	BC404597	Base Cabinet Closed On Three Sides 1200 open on one side with 1 storage shelf Dimension: 1147 x 460 x 458 mm	TO12-U 46EB	1200	460

PALUX Maître

Base Cabinets "Standard"
Standard height 510 mm

Item code	Description	Model	Length mm	Depth mm	Price €
Base Cabinets Closed On Three Sides EB		660			
all cabinets are equipped with one shelf					
	BC400351	Base Cabinet Closed On Three Sides 400 open on one side with 1 storage shelf Dimension: 347 x 660 x 458 mm	TO4-U 66EB	400	660
	BC400352	Base Cabinet Closed On Three Sides 500 open on one side with 1 storage shelf Dimension: 447 x 660 x 458 mm	TO5-U 66EB	500	660
	BC400353	Base Cabinet Closed On Three Sides 600 open on one side with 1 storage shelf Dimension: 447 x 660 x 458 mm	TO6-U 66EB	600	660
	BC404680	Base Cabinet Closed On Three Sides 700 open on one side with 1 storage shelf Dimension: 647 x 660 x 458 mm	TO7-U 66EB	700	660
	BC400354	Base Cabinet Closed On Three Sides 800 open on one side with 1 storage shelf Dimension: 747 x 660 x 458 mm	TO8-U 66EB	800	660
	BC404681	Base Cabinet Closed On Three Sides 900 open on one side with 1 storage shelf Dimension: 847 x 660 x 458 mm	TO9-U 66EB	900	660
	BC400355	Base Cabinet Closed On Three Sides 1000 open on one side with 1 storage shelf Dimension: 947 x 660 x 458 mm	TO10-U 66EB	1000	660
	BC404683	Base Cabinet Closed On Three Sides 1100 open on one side with 1 storage shelf Dimension: 1047 x 660 x 458 mm	TO11-U 66EB	1100	660
	BC400356	Base Cabinet Closed On Three Sides 1200 open on one side with 1 storage shelf Dimension: 1147 x 660 x 458 mm	TO12-U 66EB	1200	660

PALUX Maître

Base Cabinets "Standard"
Standard height 510 mm

Item code	Description	Model	Length mm	Depth mm	Price €
Base Cabinets Closed On Three Sides EB		760			
all cabinets are equipped with one shelf					
	BC400952	Base Cabinet Closed On Three Sides 400 open on one side with 1 storage shelf Dimension: 347 x 760 x 458 mm	TO4-U 76EB	400	760
	BC400953	Base Cabinet Closed On Three Sides 500 open on one side with 1 storage shelf Dimension: 447 x 760 x 458 mm	TO5-U 76EB	500	760
	BC400954	Base Cabinet Closed On Three Sides 600 open on one side with 1 storage shelf Dimension: 447 x 760 x 458 mm	TO6-U 76EB	600	760
	BC400955	Base Cabinet Closed On Three Sides 700 open on one side with 1 storage shelf Dimension: 647 x 760 x 458 mm	TO7-U 76EB	700	760
	BC400956	Base Cabinet Closed On Three Sides 800 open on one side with 1 storage shelf Dimension: 747 x 760 x 458 mm	TO8-U 76EB	800	760
	BC400957	Base Cabinet Closed On Three Sides 900 open on one side with 1 storage shelf Dimension: 847 x 760 x 458 mm	TO9-U 76EB	900	760
	BC400958	Base Cabinet Closed On Three Sides 1000 open on one side with 1 storage shelf Dimension: 947 x 760 x 458 mm	TO10-U 76EB	1000	760
	BC400980	Base Cabinet Closed On Three Sides 1100 open on one side with 1 storage shelf Dimension: 1047 x 760 x 458 mm	TO11-U 76EB	1100	760
	BC400959	Base Cabinet Closed On Three Sides 1200 open on one side with 1 storage shelf Dimension: 1147 x 760 x 458 mm	TO12-U 76EB	1200	760

PALUX Maître

Base Cabinets "Standard"
Standard height 510 mm

Item code	Description	Model	Length mm	Depth mm	Price €
Base Cabinets Open On Both Sides EB		860			
all cabinets are equipped with one shelf					
	BC404662	Base Cabinet Open On Both Sides 400-BB open on both sides with 1 storage shelf Dimension: 347 x 860 x 458 mm	TO4-U 86BB	400	860
	BC404663	Base Cabinet Open On Both Sides 500-BB open on both sides with 1 storage shelf Dimension: 447 x 860 x 458 mm	TO5-U 86BB	500	860
	BC404664	Base Cabinet Open On Both Sides 600-BB open on both sides with 1 storage shelf Dimension: 547 x 860 x 458 mm	TO6-U 86BB	600	860
	BC404665	Base Cabinet Open On Both Sides 700-BB open on both sides with 1 storage shelf Dimension: 647 x 860 x 458 mm	TO7-U 86BB	700	860
	BC404666	Base Cabinet Open On Both Sides 800-BB open on both sides with 1 storage shelf Dimension: 747 x 860 x 458 mm	TO8-U 86BB	800	860
	BC404679	Base Cabinet Open On Both Sides 900-BB open on both sides with 1 storage shelf Dimension: 847 x 860 x 458 mm	TO9-U 86BB	900	860
	BC404668	Base Cabinet Open On Both Sides 1000-BB open on both sides with 1 storage shelf Dimension: 947 x 860 x 458 mm	TO10-U 86BB	1000	860
	BC404682	Base Cabinet Open On Both Sides 1100-BB open on both sides with 1 storage shelf Dimension: 1047 x 860 x 458 mm	TO11-U 86BB	1100	860
	BC404669	Base Cabinet Open On Both Sides 1200-BB open on both sides with 1 storage shelf Dimension: 1147 x 860 x 458 mm	TO12-U 86BB	1200	860

PALUX Maître

Base Cabinets "Standard"
Standard height 510 mm

Item code	Description	Model	Length mm	Depth mm	Price €
Base Cabinets Open On Both Sides BB		960			
all cabinets are equipped with one shelf					
	BC404762	Base Cabinet Open On Both Sides 400-BB open on both sides with 1 storage shelf Dimension: 347 x 960 x 458 mm	TO4-U 96BB	400	960
	BC404763	Base Cabinet Open On Both Sides 500-BB open on both sides with 1 storage shelf Dimension: 447 x 960 x 458 mm	TO5-U 96BB	500	960
	BC404764	Base Cabinet Open On Both Sides 600-BB open on both sides with 1 storage shelf Dimension: 547 x 960 x 458 mm	TO6-U 96BB	600	960
	BC404765	Base Cabinet Open On Both Sides 700-BB open on both sides with 1 storage shelf Dimension: 647 x 960 x 458 mm	TO7-U 96BB	700	960
	BC404766	Base Cabinet Open On Both Sides 800-BB open on both sides with 1 storage shelf Dimension: 747 x 960 x 458 mm	TO8-U 96BB	800	960
	BC404779	Base Cabinet Open On Both Sides 900-BB open on both sides with 1 storage shelf Dimension: 847 x 960 x 458 mm	TO9-U 96BB	900	960
	BC404768	Base Cabinet Open On Both Sides 1000-BB open on both sides with 1 storage shelf Dimension: 947 x 960 x 458 mm	TO10-U 96BB	1000	960
	BC404782	Base Cabinet Open On Both Sides 1100-BB open on both sides with 1 storage shelf Dimension: 1047 x 960 x 458 mm	TO11-U 96BB	1100	960
	BC404769	Base Cabinet Open On Both Sides 1200-BB open on both sides with 1 storage shelf Dimension: 1147 x 960 x 458 mm	TO12-U 96BB	1200	960

PALUX Maître

Base Cabinets "Standard"
Standard height 510 mm

Item code	Description	Model	Length mm	Depth mm	Price €
Base Cabinets Open On Both Sides BB		1060			
all cabinets are equipped with one shelf					
	BC404598	Base Cabinet Open On Both Sides 400-BB open on both sides with 1 storage shelf Dimension: 347 x 1060 x 458 mm	TO4-U 106 BB	400	1060
	BC404568	Base Cabinet Open On Both Sides 500-BB open on both sides with 1 storage shelf Dimension: 447 x 1060 x 458 mm	TO5-U 106 BB	500	1060
	BC404571	Base Cabinet Open On Both Sides 600-BB open on both sides with 1 storage shelf Dimension: 547 x 1060 x 458 mm	TO6-U 106 BB	600	1060
	BC404575	Base Cabinet Open On Both Sides 700-BB open on both sides with 1 storage shelf Dimension: 647 x 1060 x 458 mm	TO7-U 106 BB	700	1060
	BC404579	Base Cabinet Open On Both Sides 800-BB open on both sides with 1 storage shelf Dimension: 747 x 1060 x 458 mm	TO8-U 106 BB	800	1060
	BC404584	Base Cabinet Open On Both Sides 900-BB open on both sides with 1 storage shelf Dimension: 847 x 1060 x 458 mm	TO9-U 106 BB	900	1060
	BC404588	Base Cabinet Open On Both Sides 1000-BB open on both sides with 1 storage shelf Dimension: 947 x 1060 x 458 mm	TO10-U 106BB	1000	1060
	BC404595	Base Cabinet Open On Both Sides 1100-BB open on both sides with 1 storage shelf Dimension: 1047 x 1060 x 458 mm	TO11-U BB 106	1100	1060
	BC404599	Base Cabinet Open On Both Sides 1200-BB open on both sides with 1 storage shelf Dimension: 1147 x 1060 x 458 mm	TO12-U 106BB	1200	1060

PALUX Maître

Base Cabinets "Standard"
Standard height 510 mm

Item code	Description	Model	Length mm	Depth mm	Price €
Base Cabinets Open On Both Sides BB		1160			
all cabinets are equipped with one shelf					
	BC404862	Base Cabinet Open On Both Sides 400-BB open on both sides with 1 storage shelf Dimension: 347 x 1160 x 458 mm	TO4-U 116 BB	400	1160
	BC404863	Base Cabinet Open On Both Sides 500-BB open on both sides with 1 storage shelf Dimension: 447 x 1160 x 458 mm	TO5-U 116 BB	500	1160
	BC404864	Base Cabinet Open On Both Sides 600-BB open on both sides with 1 storage shelf Dimension: 547 x 1160 x 458 mm	TO6-U 116 BB	600	1160
	BC404865	Base Cabinet Open On Both Sides 700-BB open on both sides with 1 storage shelf Dimension: 647 x 1160 x 458 mm	TO7-U 116 BB	700	1160
	BC404866	Base Cabinet Open On Both Sides 800-BB open on both sides with 1 storage shelf Dimension: 747 x 1160 x 458 mm	TO8-U 116 BB	800	1160
	BC404879	Base Cabinet Open On Both Sides 900-BB open on both sides with 1 storage shelf Dimension: 847 x 1160 x 458 mm	TO9-U 116 BB	900	1160
	BC404868	Base Cabinet Open On Both Sides 1000-BB open on both sides with 1 storage shelf Dimension: 947 x 1160 x 458 mm	TO10-U 116BB	1000	1160
	BC404882	Base Cabinet Open On Both Sides 1100-BB open on both sides with 1 storage shelf Dimension: 1047 x 1160 x 458 mm	TO11-U 116BB	1100	1160
	BC404869	Base Cabinet Open On Both Sides 1200-BB open on both sides with 1 storage shelf Dimension: 1147 x 1160 x 458 mm	TO12-U 116BB	1200	1160





PALUX Maître

Base Cabinets "Standard"
Standard height 510 mm

Item code	Description	Model	Length mm	Depth mm	Price €
Base Cabinets Open On Both Sides BB		1260			
all cabinets are equipped with one shelf					
	BC404870	Base Cabinet Open On Both Sides 400-BB open on both sides with 1 storage shelf Dimension: 347 x 1260 x 458 mm	TO4-U 126 BB	400	1260
	BC404871	Base Cabinet Open On Both Sides 500-BB open on both sides with 1 storage shelf Dimension: 447 x 1260 x 458 mm	TO5-U 126 BB	500	1260
	BC404872	Base Cabinet Open On Both Sides 600-BB open on both sides with 1 storage shelf Dimension: 547 x 1260 x 458 mm	TO6-U 126 BB	600	1260
	BC404873	Base Cabinet Open On Both Sides 700-BB open on both sides with 1 storage shelf Dimension: 647 x 1260 x 458 mm	TO7-U 126 BB	700	1260
	BC404874	Base Cabinet Open On Both Sides 800-BB open on both sides with 1 storage shelf Dimension: 747 x 1260 x 458 mm	TO8-U 126 BB	800	1260
	BC404875	Base Cabinet Open On Both Sides 900-BB open on both sides with 1 storage shelf Dimension: 847 x 1260 x 458 mm	TO9-U 126 BB	900	1260
	BC404876	Base Cabinet Open On Both Sides 1000-BB open on both sides with 1 storage shelf Dimension: 947 x 1260 x 458 mm	TO10-U 126BB	1000	1260
	BC404877	Base Cabinet Open On Both Sides 1100-BB open on both sides with 1 storage shelf Dimension: 1047 x 1260 x 458 mm	TO11-U 126BB	1100	1260
	BC404878	Base Cabinet Open On Both Sides 1200-BB open on both sides with 1 storage shelf Dimension: 1147 x 1260 x 458 mm	TO12-U 126BB	1200	1260

PALUX Maître

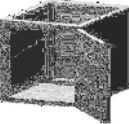
Base Cabinets "Standard"
Standard height 510 mm

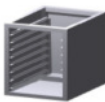
	Item code	Description	Model	Length mm	Depth mm	Price €
		Folding Door Kit				
		Base Cabinets For Folding Closed On Three Sides				
		<u>Folding Door Kit not available for H2</u>				
	BC400857	Folding Door Kit 400 Folding door hinged on the left or right	FT-4-U	400		
<i>Suitable for all TO-U Base Cabinets</i>	BC400858	Folding Door Kit 500 Folding door hinged on the left or right	FT-5-U	500		
	BC400859	Folding Door Kit 600 Folding door hinged on the left or right	FT-6-U	600		
	BC400860	Folding Door Kit 800 Folding door hinged on the left or right	FT-8-U	800		
	BC400865	Folding Door Kit 1000 Folding door hinged on the left or right	FT-10-U	1000		
<i>Suitable for all TO-U Base Cabinets</i>	BC400866	Folding Door Kit 1200 Folding door hinged on the left or right	FT-12-U	1200		
		Base cabinets for Deep Fat Fryer				
		Drop-In Unit	760			
		Base Cabinets For Folding Closed On Three Sides				
	BC404944	Base Cabinet For Deep Fat Fryer 400 L 1 folding door, Door hinged on the left	SFFP-U51-76-1B-L	400	760	
	BC404945	Base Cabinet For Deep Fat Fryer 400 R for drop-in unit, Single pan 1 folding door, Door hinged on the right	SFFP-U51-76-1B-R	400	760	
	BC404970	Base Cabinet For Deep Fat Fryer 500 L for drop-in unit, Single pan 1 folding door, Door hinged on the left	SFFP-U51-76-1B-L	500	760	
	BC404971	Base Cabinet For Deep Fat Fryer 500 R for drop-in unit, Single pan 1 folding door, Door hinged on the right	SFFP-U51-76-1B-R	500	760	
	BC404946	Base Cabinet For Deep Fat Fryer 600 L for drop-in unit, Dual pan 1 folding door, Door hinged on the left	SFFP-U51-76-2B-L	600	760	
	BC404947	Base Cabinet For Deep Fat Fryer 600 R for drop-in unit, Dual pan 1 folding door, Door hinged on the right	SFFP-U51-76-2B-R	600	760	
	BC404972	Base Cabinet For Deep Fat Fryer 700 LR for drop-in unit, Dual pan 2 folding doors, doors hinged on the right and left	SFFP-U51-76-2B-LR	700	760	
		Base cabinets for Pasta cooker				
	BC404920	Base Cabinet For Pasta Cooker GN 1/1 400 L 1 folding door, door hinged on the left	SFP4-U51-L-76-EB	400	760	
	BC404921	Base Cabinet For Pasta Cooker GN 1/1 400 R 1 folding door, door hinged on the right	SFP4-U51-R-76-EB	400	760	
	BC404922	Base Cabinet For Pasta Cooker GN 1/1 600 L 1 folding door, door hinged on the left	SFP6-U51-L-76-EB	600	760	
	BC404923	Base Cabinet For Pasta Cooker GN 1/1 600 R 1 folding door, door hinged on the right	SFP6-U51-R-76-EB	600	760	
	BC404924	Base Cabinet For Pasta Cooker GN 1/1 700 LR 2 folding doors, doors hinged on the right and left	SFP7-U51-LR-76-EB	700	760	
		Base cabinets with GN supports	760			
		All base cabinets are equipped with 3 GN-inserts				
	BC400970	Base Cabinet With GN Supports 400 open on one side, with 3 supports for GN 1/1	NO4-U 76	400	760	
	BC400971	Base Cabinet With GN Supports 600 open on one side, with 3 supports for GN 2/1	NO6-U 76	600	760	

PALUX Maître

Base Cabinets "Standard"
Standard height 510 mm

Item code	Description	Model	Length mm	Depth mm	Price €
Base cabinets for installations					
CAUTION					
The installation compartments / sub-distributions must not be located directly on ovens, heating cabinets or other heat sources.					
873799	Base Cabinet For Installations 200 terminal box for installations, up to 6 connectons	200 x 510 mm		Pcs.	
873829	Base Cabinet For Installations 300 terminal box for installations, up to 10 connectons	300 x 510 mm		Pcs.	
887439	Base Cabinet For Installations 400 terminal box for installations, up to 14 connectons	400 x 510 mm		Pcs.	
888566	Base Cabinet For Installations >200 - 299 terminal box for installations, up to 6 connectons	2xx x 510 mm		Pcs.	
888567	Base Cabinet For Installations >300 - 399 terminal box for installations, up to 10 connectons	3xx x 510 mm		Pcs.	
Base cabinets for Generator					
compartment for induction generator					
892814	Base Cabinet For Generator 200 compartment for up to 4 induction generators	GF2-U76	200	760	
892815	Base Cabinet For Generator 400 compartment for up to 8 induction generators	GF4-U76	400	760	
Base cabinets for Holdomat					
Base cabinet for a small Holdomat 3 x GN 1/1					
BC400986	Base Cabinet For Holdomat 500 open on one side, for Hold-o-mat Standard 300, KTM 311, Household 323 Console and cut out for plug included	HDS5-U76	500	760	
	>> <i>socket</i>	<i>see page</i>			22
Base cabinet for Alto Shaam					
suitable for Alto Shaam warming drawer element					
BC400983	Base Cabinet For Alto-Shaam 700 open on one side, cut out for plug included		700	760	
	>> <i>socket</i>	<i>see page</i>			22

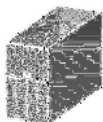

PALUX Maître

Base Cabinets "Hygiene-H2"

Hygienic design H2 Standard height 510 mm

Item code	Description	Model	Length mm	Depth mm	Price €
Hygiene base cabinets H2, closed on three sides		340			
all cabinets are equipped with one shelf					
	BZ405970	Base Cabinet H2 Closed On Three Sides 400 Open on one side 1 storage shelf Dimension: 336 x 329 x 430 mm	TO4UV-H2-34-EB	400	340
	BZ405971	Base Cabinet H2 Closed On Three Sides 500 Open on one side 1 storage shelf Dimension: 436 x 329 x 430 mm	TO5UV-H2-34-EB	500	340
	BZ405972	Base Cabinet H2 Closed On Three Sides 600 Open on one side 1 storage shelf Dimension: 536 x 329 x 430 mm	TO6UV-H2-34-EB	600	340
	BZ405973	Base Cabinet H2 Closed On Three Sides 700 Open on one side 1 storage shelf Dimension: 636 x 329 x 430 mm	TO7UV-H2-34-EB	700	340
	BZ405974	Base Cabinet H2 Closed On Three Sides 800 Open on one side 1 storage shelf Dimension: 736 x 329 x 430 mm	TO8UV-H2-34-EB	800	340
	BZ405975	Base Cabinet H2 Closed On Three Sides 900 Open on one side 1 storage shelf Dimension: 836 x 329 x 430 mm	TO9UV-H2-34-EB	900	340
	BZ405976	Base Cabinet H2 Closed On Three Sides 1000 Open on one side 1 storage shelf Dimension: 936 x 329 x 430 mm	TO10UV-H2-34-EB	1000	340
	BZ405977	Base Cabinet H2 Closed On Three Sides 1100 Open on one side 1 storage shelf Dimension: 1036 x 329 x 430 mm	TO11UV-H2-34-EB	1100	340
	BZ405978	Base Cabinet H2 Closed On Three Sides 1200 Open on one side 1 storage shelf Dimension: 1136 x 329 x 430 mm	TO12UV-H2-34-EB	1200	340

PALUX Maître

Base Cabinets "Hygiene-H2"

Hygienic design H2 Standard height 510 mm

Item code	Description	Model	Length mm	Depth mm	Price €
Hygiene base cabinets H2, closed on three sides		440			
all cabinets are equipped with one shelf					
	BZ405990	Base Cabinet H2 Closed On Three Sides 400 Open on one side 1 storage shelf Dimension: 336 x 429 x 430 mm	TO4UV-H2-44-EB	400	440
	BZ405991	Base Cabinet H2 Closed On Three Sides 500 Open on one side 1 storage shelf Dimension: 436 x 429 x 430 mm	TO5UV-H2-44-EB	500	440
	BZ405992	Base Cabinet H2 Closed On Three Sides 600 Open on one side 1 storage shelf Dimension: 536 x 429 x 430 mm	TO6UV-H2-44-EB	600	440
	BZ405993	Base Cabinet H2 Closed On Three Sides 700 Open on one side 1 storage shelf Dimension: 636 x 429 x 430 mm	TO7UV-H2-44-EB	700	440
	BZ405994	Base Cabinet H2 Closed On Three Sides 800 Open on one side 1 storage shelf Dimension: 736 x 429 x 430 mm	TO8UV-H2-44-EB	800	440
	BZ405995	Base Cabinet H2 Closed On Three Sides 900 Open on one side 1 storage shelf Dimension: 836 x 429 x 430 mm	TO9UV-H2-44-EB	900	440
	BZ405996	Base Cabinet H2 Closed On Three Sides 1000 Open on one side 1 storage shelf Dimension: 936 x 429 x 430 mm	TO10UV-H2-44-EB	1000	440
	BZ405997	Base Cabinet H2 Closed On Three Sides 1100 Open on one side 1 storage shelf Dimension: 1036 x 429 x 430 mm	TO11UV-H2-44-EB	1100	440
	BZ405998	Base Cabinet H2 Closed On Three Sides 1200 Open on one side 1 storage shelf Dimension: 1136 x 429 x 430 mm	TO12UV-H2-44-EB	1200	440

PALUX Maître

Base Cabinets "Hygiene-H2"

Hygienic design H2 Standard height 510 mm

Item code	Description	Model	Length mm	Depth mm	Price €
Hygiene base cabinets H2, closed on three sides		640			
all cabinets are equipped with one shelf					
	BZ405020	Base Cabinet H2 Closed On Three Sides 400 Open on one side 1 storage shelf Dimension: 336 x 628 x 430 mm	TO4UV-H2-64-EB	400	640
	BZ405021	Base Cabinet H2 Closed On Three Sides 500 Open on one side 1 storage shelf Dimension: 436 x 629 x 430 mm	TO5UV-H2-64-EB	500	640
	BZ405022	Base Cabinet H2 Closed On Three Sides 600 Open on one side 1 storage shelf Dimension: 536 x 629 x 430 mm	TO6UV-H2-64-EB	600	640
	BZ405019	Base Cabinet H2 Closed On Three Sides 700 Open on one side 1 storage shelf Dimension: 636 x 629 x 430 mm	TO7UV-H2-64-EB	700	640
	BZ405023	Base Cabinet H2 Closed On Three Sides 800 Open on one side 1 storage shelf Dimension: 736 x 629 x 430 mm	TO8UV-H2-64-EB	800	640
	BZ405028	Base Cabinet H2 Closed On Three Sides 900 Open on one side 1 storage shelf Dimension: 836 x 629 x 430 mm	TO9UV-H2-64-EB	900	640
	BZ405024	Base Cabinet H2 Closed On Three Sides 1000 Open on one side 1 storage shelf Dimension: 936 x 629 x 430 mm	TO10UV-H2-64-EB	1000	640
	BZ405029	Base Cabinet H2 Closed On Three Sides 1100 Open on one side 1 storage shelf Dimension: 1036 x 629 x 430 mm	TO11UV-H2-64-EB	1100	640
	BZ405025	Base Cabinet H2 Closed On Three Sides 1200 Open on one side 1 storage shelf Dimension: 1136 x 629 x 430 mm	TO12UV-H2-64-EB	1200	640

PALUX Maître

Base Cabinets "Hygiene-H2"

Hygienic design H2 Standard height 510 mm

Item code	Description	Model	Length mm	Depth mm	Price €
Hygiene base cabinets H2, closed on three sides		710			
all cabinets are equipped with one shelf					
	BZ405642	Base Cabinet H2 Closed On Three Sides 400 Open on one side 1 storage shelf Dimension: 336 x 699 x 430 mm	TO4UV-H2-71-EB	400	710
	BZ405643	Base Cabinet H2 Closed On Three Sides 500 Open on one side 1 storage shelf Dimension: 436 x 699 x 430 mm	TO5UV-H2-71-EB	500	710
	BZ405644	Base Cabinet H2 Closed On Three Sides 600 Open on one side 1 storage shelf Dimension: 536 x 699 x 430 mm	TO6UV-H2-71-EB	600	710
	BZ405645	Base Cabinet H2 Closed On Three Sides 700 Open on one side 1 storage shelf Dimension: 636 x 699 x 430 mm	TO7UV-H2-71-EB	700	710
	BZ405646	Base Cabinet H2 Closed On Three Sides 800 Open on one side 1 storage shelf Dimension: 736 x 699 x 430 mm	TO8UV-H2-71-EB	800	710
	BZ405647	Base Cabinet H2 Closed On Three Sides 900 Open on one side 1 storage shelf Dimension: 836 x 699 x 430 mm	TO9UV-H2-71-EB	900	710
	BZ405648	Base Cabinet H2 Closed On Three Sides 1000 Open on one side 1 storage shelf Dimension: 936 x 699 x 430 mm	TO10UV-H2-71-EB	1000	710
	BZ405649	Base Cabinet H2 Closed On Three Sides 1100 Open on one side 1 storage shelf Dimension: 1036 x 699 x 430 mm	TO11UV-H2-71-EB	1100	710
	BZ405650	Base Cabinet H2 Closed On Three Sides 1200 Open on one side 1 storage shelf Dimension: 1136 x 699 x 430 mm	TO12UV-H2-71-EB	1200	710

PALUX Maître

Base Cabinets "Hygiene-H2"

Hygienic design H2 Standard height 510 mm

Item code	Description	Model	Length mm	Depth mm	Price €
<u>Hygiene base cabinets H2, open on both sides</u>		860			
all cabinets are equipped with one shelf					
	BZ405682	Base Cabinet H2 Open On Both Sides 400-BB open on both sides 1 storage shelf Dimension: 336 x 849 x 430 mm	TO4UV-H2-86-BB	400	860
	BZ405683	Base Cabinet H2 Open On Both Sides 500-BB open on both sides 1 storage shelf Dimension: 436 x 849 x 430 mm	TO5UV-H2-86-BB	500	860
	BZ405684	Base Cabinet H2 Open On Both Sides 600-BB open on both sides 1 storage shelf Dimension: 536 x 849 x 430 mm	TO6UV-H2-86-BB	600	860
	BZ405685	Base Cabinet H2 Open On Both Sides 700-BB open on both sides 1 storage shelf Dimension: 636 x 849 x 430 mm	TO7UV-H2-86-BB	700	860
	BZ405686	Base Cabinet H2 Open On Both Sides 800-BB open on both sides 1 storage shelf Dimension: 736 x 849 x 430 mm	TO8UV-H2-86-BB	800	860
	BZ405687	Base Cabinet H2 Open On Both Sides 900-BB open on both sides 1 storage shelf Dimension: 836 x 849 x 430 mm	TO9UV-H2-86-BB	900	860
	BZ405688	Base Cabinet H2 Open On Both Sides 1000-BB open on both sides 1 storage shelf Dimension: 936 x 849 x 430 mm	TO10UV-H2-86-BB	1000	860
	BZ405689	Base Cabinet H2 Open On Both Sides 1100-BB open on both sides 1 storage shelf Dimension: 1036 x 849 x 430 mm	TO11UV-H2-86-BB	1100	860
	BZ405690	Base Cabinet H2 Open On Both Sides 1200-BB open on both sides 1 storage shelf Dimension: 1136 x 849 x 430 mm	TO12UV-H2-86-BB	1200	860

PALUX Maître

Base Cabinets "Hygiene-H2"

Hygienic design H2 Standard height 510 mm

Item code	Description	Model	Length mm	Depth mm	Price €
<u>Hygiene base cabinets H2, open on both sides</u>		960			
all cabinets are equipped with one shelf					
	BZ405702	Base Cabinet H2 Open On Both Sides 400-BB open on both sides 1 storage shelf Dimension: 336 x 949 x 430 mm	TO4UV-H2-96-BB	400	960
	BZ405703	Base Cabinet H2 Open On Both Sides 500-BB open on both sides 1 storage shelf Dimension: 436 x 949 x 430 mm	TO5UV-H2-96-BB	500	960
	BZ405704	Base Cabinet H2 Open On Both Sides 600-BB open on both sides 1 storage shelf Dimension: 536 x 949 x 430 mm	TO6UV-H2-96-BB	600	960
	BZ405705	Base Cabinet H2 Open On Both Sides 700-BB open on both sides 1 storage shelf Dimension: 636 x 949 x 430 mm	TO7UV-H2-96-BB	700	960
	BZ405706	Base Cabinet H2 Open On Both Sides 800-BB open on both sides 1 storage shelf Dimension: 736 x 949 x 430 mm	TO8UV-H2-96-BB	800	960
	BZ405707	Base Cabinet H2 Open On Both Sides 900-BB open on both sides 1 storage shelf Dimension: 836 x 949 x 430 mm	TO9UV-H2-96-BB	900	960
	BZ405708	Base Cabinet H2 Open On Both Sides 1000-BB open on both sides 1 storage shelf Dimension: 936 x 949 x 430 mm	TO10UV-H2-96-BB	1000	960
	BZ405709	Base Cabinet H2 Open On Both Sides 1100-BB open on both sides 1 storage shelf Dimension: 1036 x 949 x 430 mm	TO11UV-H2-96-BB	1100	960
	BZ405710	Base Cabinet H2 Open On Both Sides 1200-BB open on both sides 1 storage shelf Dimension: 1136 x 949 x 430 mm	TO12UV-H2-96-BB	1200	960

PALUX Maître

Base Cabinets "Hygiene-H2"

Hygienic design H2 Standard height 510 mm

Item code	Description	Model	Length mm	Depth mm	Price €
Hygiene base cabinets H2, open on both sides		1060			
all cabinets are equipped with one shelf					
	BZ405722	Base Cabinet H2 Open On Both Sides 400-BB open on both sides 1 storage shelf Dimension: 336 x 1049 x 430 mm	TO4UV-H2-106-BB	400	1060
	BZ405723	Base Cabinet H2 Open On Both Sides 500-BB open on both sides 1 storage shelf Dimension: 436 x 1049 x 430 mm	TO5UV-H2-106-BB	500	1060
	BZ405724	Base Cabinet H2 Open On Both Sides 600-BB open on both sides 1 storage shelf Dimension: 536 x 1049 x 430 mm	TO6UV-H2-106-BB	600	1060
	BZ405725	Base Cabinet H2 Open On Both Sides 700-BB open on both sides 1 storage shelf Dimension: 636 x 1049 x 430 mm	TO7UV-H2-106-BB	700	1060
	BZ405726	Base Cabinet H2 Open On Both Sides 800-BB open on both sides 1 storage shelf Dimension: 736 x 1049 x 430 mm	TO8UV-H2-106-BB	800	1060
	BZ405727	Base Cabinet H2 Open On Both Sides 900-BB open on both sides 1 storage shelf Dimension: 836 x 1049 x 430 mm	TO9UV-H2-106-BB	900	1060
	BZ405728	Base Cabinet H2 Open On Both Sides 1000-BB open on both sides 1 storage shelf Dimension: 936 x 1049 x 430 mm	TO10UV-H2-106-BB	1000	1060
	BZ405729	Base Cabinet H2 Open On Both Sides 1100-BB open on both sides 1 storage shelf Dimension: 1036 x 1049 x 430 mm	TO11UV-H2-106-BB	1100	1060
	BZ405730	Base Cabinet H2 Open On Both Sides 1200-BB open on both sides 1 storage shelf Dimension: 1136 x 1049 x 430 mm	TO12UV-H2-106-BB	1200	1060

PALUX Maître

Base Cabinets "Hygiene-H2"

Hygienic design H2 Standard height 510 mm

Item code	Description	Model	Length mm	Depth mm	Price €
Hygiene base cabinets H2, open on both sides		1160			
all cabinets are equipped with one shelf					
	BZ405742	Base Cabinet H2 Open On Both Sides 400-BB open on both sides 1 storage shelf Dimension: 336 x 1149 x 430 mm	TO4UV-H2-116-BB	400	1160
	BZ405743	Base Cabinet H2 Open On Both Sides 500-BB open on both sides 1 storage shelf Dimension: 436 x 1149 x 430 mm	TO5UV-H2-116-BB	500	1160
	BZ405744	Base Cabinet H2 Open On Both Sides 600-BB open on both sides 1 storage shelf Dimension: 536 x 1149 x 430 mm	TO6UV-H2-116-BB	600	1160
	BZ405745	Base Cabinet H2 Open On Both Sides 700-BB open on both sides 1 storage shelf Dimension: 636 x 1149 x 430 mm	TO7UV-H2-116-BB	700	1160
	BZ405746	Base Cabinet H2 Open On Both Sides 800-BB open on both sides 1 storage shelf Dimension: 736 x 1149 x 430 mm	TO8UV-H2-116-BB	800	1160
	BZ405747	Base Cabinet H2 Open On Both Sides 900-BB open on both sides 1 storage shelf Dimension: 836 x 1149 x 430 mm	TO9UV-H2-116-BB	900	1160
	BZ405748	Base Cabinet H2 Open On Both Sides 1000-BB open on both sides 1 storage shelf Dimension: 936 x 1149 x 430 mm	TO10UV-H2-116-BB	1000	1160
	BZ405749	Base Cabinet H2 Open On Both Sides 1100-BB open on both sides 1 storage shelf Dimension: 1036 x 1149 x 430 mm	TO11UV-H2-116-BB	1100	1160
	BZ405750	Base Cabinet H2 Open On Both Sides 1200-BB open on both sides 1 storage shelf Dimension: 1136 x 1149 x 430 mm	TO12UV-H2-116-BB	1200	1160

PALUX Maître

Base Cabinets "Hygiene-H2"

Hygienic design H2 Standard height 510 mm

Item code	Description	Model	Length mm	Depth mm	Price €
<u>Hygiene base cabinets H2, open on both sides</u>		1260			
all cabinets are equipped with one shelf					
	BZ405762	Base Cabinet H2 Open On Both Sides 400-BB open on both sides 1 storage shelf Dimension: 336 x 1249 x 430 mm	TO4UV-H2-126-BB	400	1260
	BZ405763	Base Cabinet H2 Open On Both Sides 500-BB open on both sides 1 storage shelf Dimension: 436 x 1249 x 430 mm	TO5UV-H2-126-BB	500	1260
	BZ405764	Base Cabinet H2 Open On Both Sides 600-BB open on both sides 1 storage shelf Dimension: 536 x 1249 x 430 mm	TO6UV-H2-126-BB	600	1260
	BZ405765	Base Cabinet H2 Open On Both Sides 700-BB open on both sides 1 storage shelf Dimension: 636 x 1249 x 430 mm	TO7UV-H2-126-BB	700	1260
	BZ405766	Base Cabinet H2 Open On Both Sides 800-BB open on both sides 1 storage shelf Dimension: 736 x 1249 x 430 mm	TO8UV-H2-126-BB	800	1260
	BZ405767	Base Cabinet H2 Open On Both Sides 900-BB open on both sides 1 storage shelf Dimension: 836 x 1249 x 430 mm	TO9UV-H2-126-BB	900	1260
	BZ405768	Base Cabinet H2 Open On Both Sides 1000-BB open on both sides 1 storage shelf Dimension: 936 x 1249 x 430 mm	TO10UV-H2-126-BB	1000	1260
	BZ405769	Base Cabinet H2 Open On Both Sides 1100-BB open on both sides 1 storage shelf Dimension: 1036 x 1249 x 430 mm	TO11UV-H2-126-BB	1100	1260
	BZ405770	Base Cabinet H2 Open On Both Sides 1200-BB open on both sides 1 storage shelf Dimension: 1136 x 1249 x 430 mm	TO12UV-H2-126-BB	1200	1260

PALUX Maître

Base Cabinets "Hygiene-H2"

Hygienic design H2 Standard height 510 mm

Item code	Description	Model	Length mm	Depth mm	Price €
Hygiene base cabinets H2 with folding door		735			
closed on three sides					
all cabinets are equipped with one shelf					
	BZ405780	Hygiene Base Cabinet H2 With Folding Door 400L 1 storage shelf Door hinged on the left Dimension: 336 x 724 x 430 mm	TF4UV-H2-73-EB-L	400	735
	BZ405781	Hygiene Base Cabinet H2 With Folding Door 400R 1 storage shelf Door hinged on the left Dimension: 336 x 724 x 430 mm	TF4UV-H2-73-EB-R	400	735
	BZ405782	Hygiene Base Cabinet H2 With Folding Door 500 L 1 storage shelf Door hinged on the left Dimension: 436 x 724 x 430 mm	TF5UV-H2-73-EB-L	500	735
	BZ405783	Hygiene Base Cabinet H2 With Folding Door 500R 1 storage shelf Door hinged on the right Dimension: 436 x 724 x 430 mm	TF5UV-H2-73-EB-R	500	735
	BZ405784	Hygiene Base Cabinet H2 With Folding Door 600L 1 storage shelf Door hinged on the right Dimension: 536 x 724 x 430 mm	TF6UV-H2-73-EB-L	600	735
	BZ405785	Hygiene Base Cabinet H2 With Folding Door 600R 1 storage shelf Door hinged on the right Dimension: 536 x 724 x 430 mm	TF6UV-H2-73-EB-R	600	735
	BZ405786	Hygiene Base Cabinet H2 With Folding Doors 800L/R 1 storage shelf Door hinged on the left and right Dimension: 736 x 724 x 430 mm	T2F8UV-H2-73-EB-L/R	800	735
	BZ405787	Hygiene Base Cabinet H2 With Folding Doors 1000L/R 1 storage shelf Door hinged on the left and right Dimension: 936 x 724 x 430 mm	T2F10UV-H2-73-EB-L/R	1000	735
	BZ405788	Hygiene Base Cabinet H2 With Folding Doors 1200L/R 1 storage shelf Door hinged on the left and right Dimension: 1136 x 724 x 430 mm	T2F12UV-H2-73-EB-L/R	1200	735
Typ: -R = hinged right / -L = hinged left					

PALUX Maître

Base Cabinets "Hygiene-H2"

Hygienic design H2 Standard height 510 mm

Item code	Description	Model	Length mm	Depth mm	Price €
<u>Hygiene base cabinets H2 with folding door closed on three sides</u>		735			
<u>Hygiene base cabinet H2 for Deep Fat Fryers Drop-in unit</u>					
	BZ404938	Base Cabinet H2 For Deep Fat Fryer 400L For drop-in unit, Single pan Door hinged on the left	SFFP-U51-H2-76-1B-L	400	735
	BZ404939	Base Cabinet H2 For Deep Fat Fryer 400 R For drop-in unit, Single pan Door hinged on the right	SFFP-U51-H2-76-1B-R	400	735
	BZ404940	Base Cabinet H2 For Deep Fat Fryer 600 L For drop-in unit, Single pan Door hinged on the left	SFFP-U51-H2-76-2B-L	600	735
	BZ404941	Base Cabinet H2 For Deep Fat Fryer 600 R For drop-in unit, Single pan Door hinged on the right	SFFP-U51-H2-76-2B-R	600	735
<u>Hygiene base cabinets H2 for PALUX Fry Star Deep Fat Fryers</u>					
	BZ400954	Base Cabinet H2 For Deep Fat Fryer 300L For drop-in fryer Fry Star, Single pan for type AE Door hinged on the left	SFFP-U51-H2-76-1B-L	300	735
	BZ400955	Base Cabinet H2 For Deep Fat Fryer 300 R For drop-in fryer Fry Star, Single pan for type AE Door hinged on the right	SFFP-U51-H2-76-1B-R	300	735
	BZ400956	Base Cabinet H2 For Deep Fat Fryer 400 L For drop-in fryer Fry Star, Single pan for type BE Door hinged on the left	SFFP-U51-H2-76-2B-L	400	735
	BZ400957	Base Cabinet H2 For Deep Fat Fryer 400 R For drop-in fryer Fry Star, Single pan for type BE Door hinged on the right	SFFP-U51-H2-76-2B-R	400	735
	BZ400958	Base Cabinet H2 For Deep Fat Fryer 500 L For drop-in fryer Fry Star, 1/2 single pan for type CE/ DE Door hinged on the left	SFFP-U51-H2-76-2B-L	500	735
	BZ400959	Base Cabinet H2 For Deep Fat Fryer 500 R For drop-in fryer Fry Star, 1/2 single pan for type CE/ DE Door hinged on the right	SFFP-U51-H2-76-2B-R	500	735
<u>Hygiene base cabinets H2 for Pasta cooker</u>					
	BZ404926	Base Cabinet H2 With Folding Door 400 L For Pasta Cooker GN 1/1	SFP4-U51-H2-L-76-EB	400	735
	BZ404927	Base Cabinet H2 With Folding Door 400 R Door hinged on the right	SFP4-U51-H2-R-76-EB	400	735
	BZ404928	Base Cabinet H2 With Folding Door 600 L For Pasta Cooker GN 1/1 with lifting baskets Door hinged on the left	SFP4-U51-H2-L-76-EB	600	735

PALUX Maître

Base Cabinets "Hygiene-H2"

Hygienic design H2 Standard height 510 mm

Item code	Description	Model	Length mm	Depth mm	Price €
BZ404929	Base Cabinet H2 With Folding Door 600 R For Pasta Cooker GN 1/1 with lifting baskets Door hinged on the right	SFP6-U51-H2-R-76-EB	600	735	
BZ404930	Base Cabinet H2 With Folding Door 700 LR For Pasta Cooker GN 1/1 - Transverse installation Door hinged on the left and right Typ: -R = hinged right / -L = hinged left	SFP7-U51-H2-LR-76-EB	700	735	
	Hygiene base cabinets H2 with GN supports all cabinets are equipped with 3 supports for GN 1/1	710			
	BZ405920 Base Cabinet H2 With GN Supports 400 Open on one side with 3 supports for GN 1/1 Dimension: 328 x 699 x 430 mm	NO4UV-H2-71-EB	400	710	
	BZ405921 Base Cabinet H2 With GN Supports 600 Open on one side with 3 supports for GN 2/1 Dimension: 528 x 699 x 430 mm	NO6UV-H2-71-EB	600	710	
	Base Cabinets H2 With GN Support and Folding Door one-sided all cabinets are equipped with 3 supports for GN 1/1 inner dimension: 528 x 699 x 430 mm	735			
	BZ405930 Base Cabinet H2 With GN Supports 400 L Door hinged on the left with 3 supports for GN 1/1 Dimension: 328 x 699 x 430 mm	NF4UV-H2-73-EB-L	400	735	
	BZ405931 Base Cabinet H2 With GN Supports 400 R Door hinged on the right with 3 supports for GN 1/1 Dimension: 328 x 699 x 430 mm	NF4UV-H2-73-EB-R	400	735	
	BZ405932 Base Cabinet H2 With GN Supports 600 L Door hinged on the left with 3 supports for GN 1/1 Dimension: 528 x 699 x 430 mm	NF6UV-H2-73-EB-L	600	735	
	BZ405933 Base Cabinet H2 With GN Supports 600 R Door hinged on the right with 3 supports for GN 1/1 Dimension: 528 x 699 x 430 mm	NF6UV-H2-73-EB-R	600	735	

PALUX Maître

Base Cabinets "Hygiene-H2"

Hygienic design H2 Standard height 510 mm

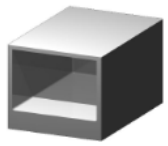
Item code	Description	Model	Length mm	Depth mm	Price €
Hygiene Base Cabinets H2 With 2 Drawers		735			
	All Drawers are equipped with full pull-out frames Possibility to use GN-Containers				
	BZ405940 Hygiene Base Cabinet H2 With 2 Drawers 400 2 drawers for GN 1/1, drawer depth 150 mm	2S4UV-H2-73-EB	400	735	
	BZ405941 Hygiene Base Cabinet H2 With 2 Drawers 600 Open on one side, for Holdomat 3 x GN 1/1	2S6UV-H2-73-EB	600	735	
Hygiene Base Cabinets H2 For Holdomat		710			
	BZ405950 Hygiene Base Cabinet H2 For Holdomat 500 Dimension: 447 x 710 x 350 mm open on one side, for Holdomat Standard 311, KTM 311, Householdt 323 cut out for plug included >> socket	HO5UV-H2-71-EB	500	710	
		see page			21

PALUX Maître

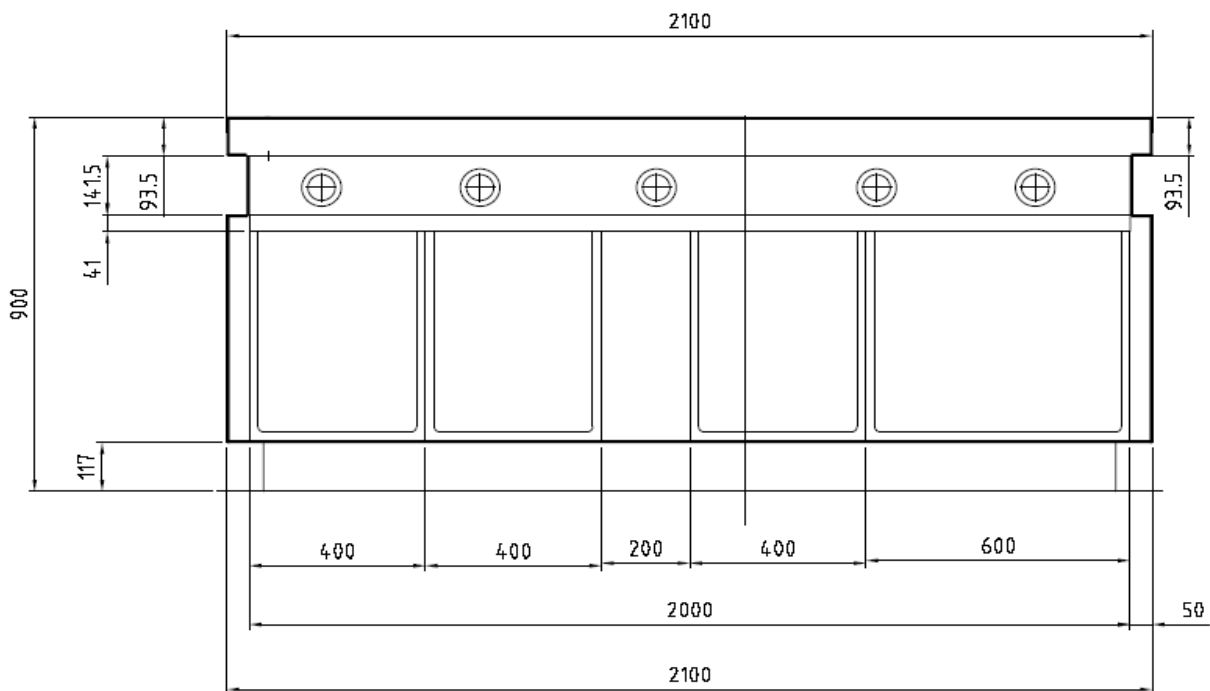
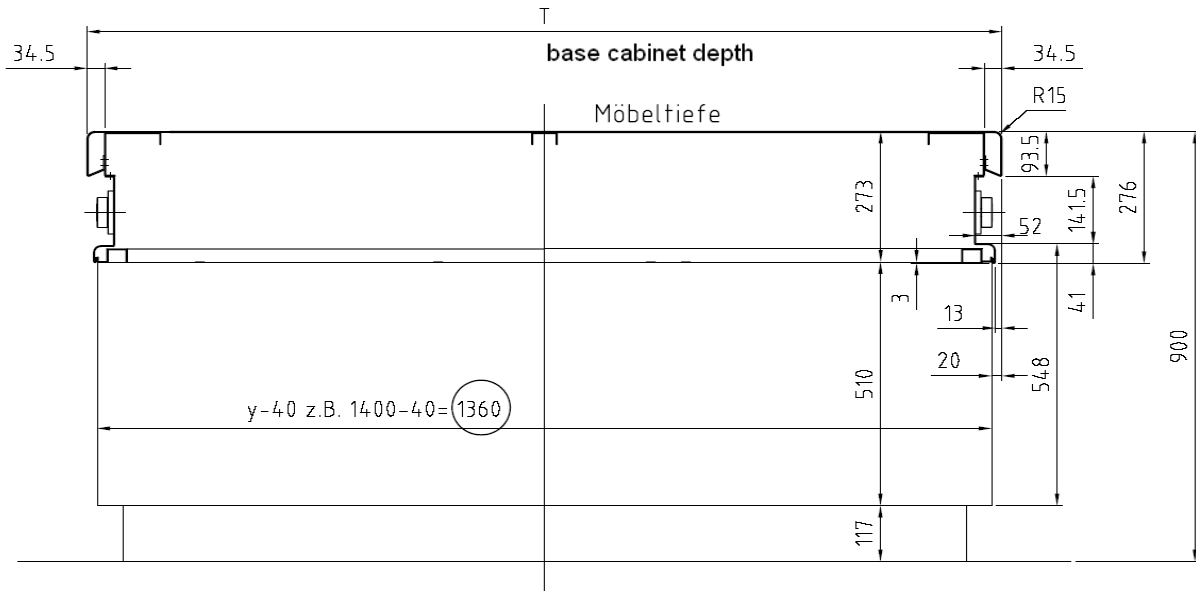

PALUX Maître

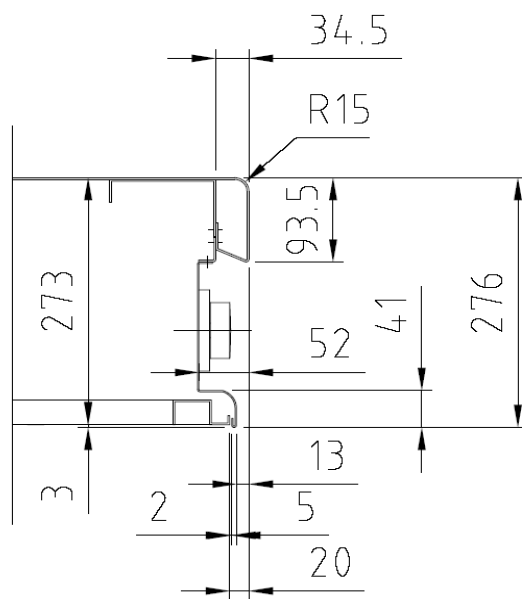
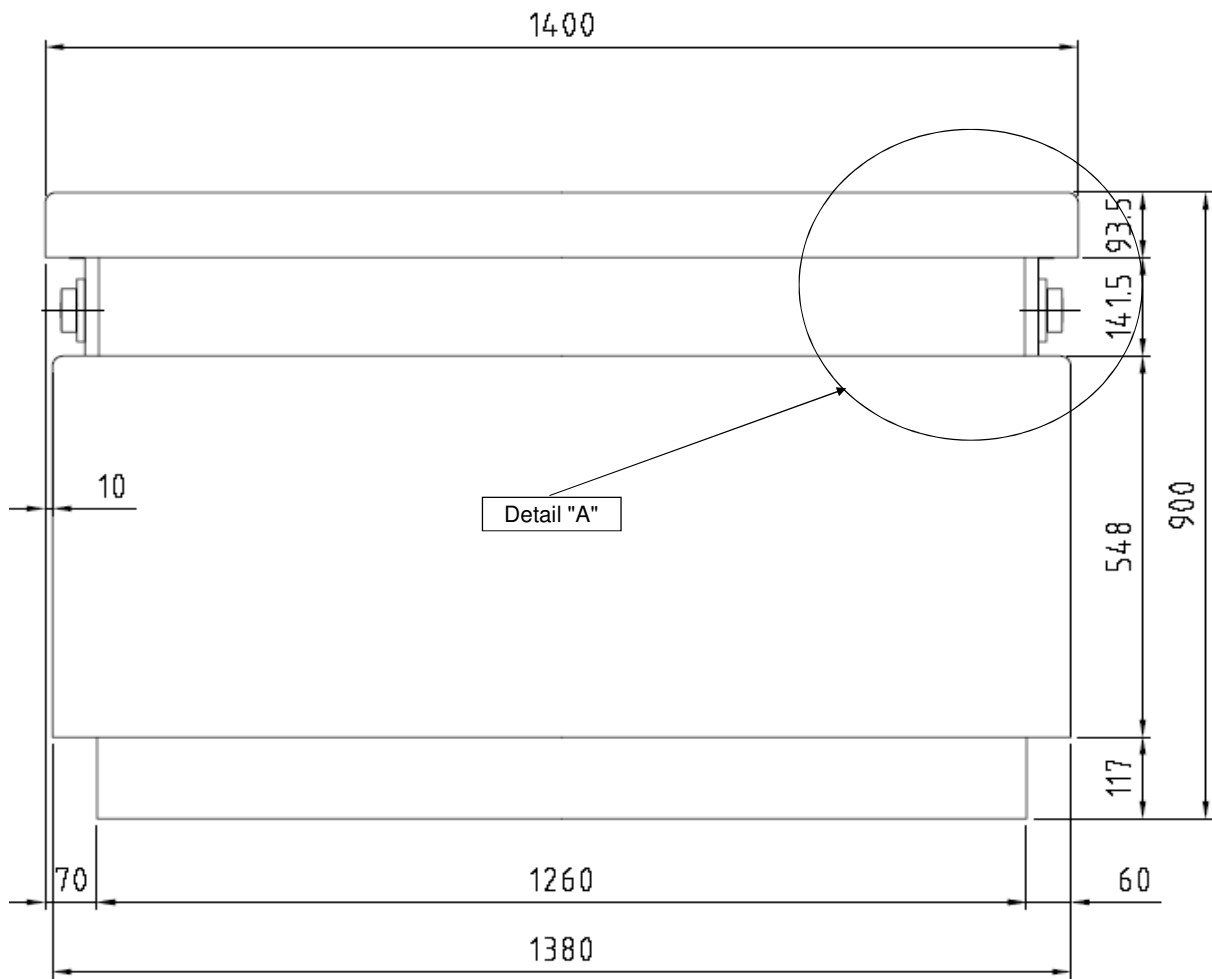

PALUX Maître

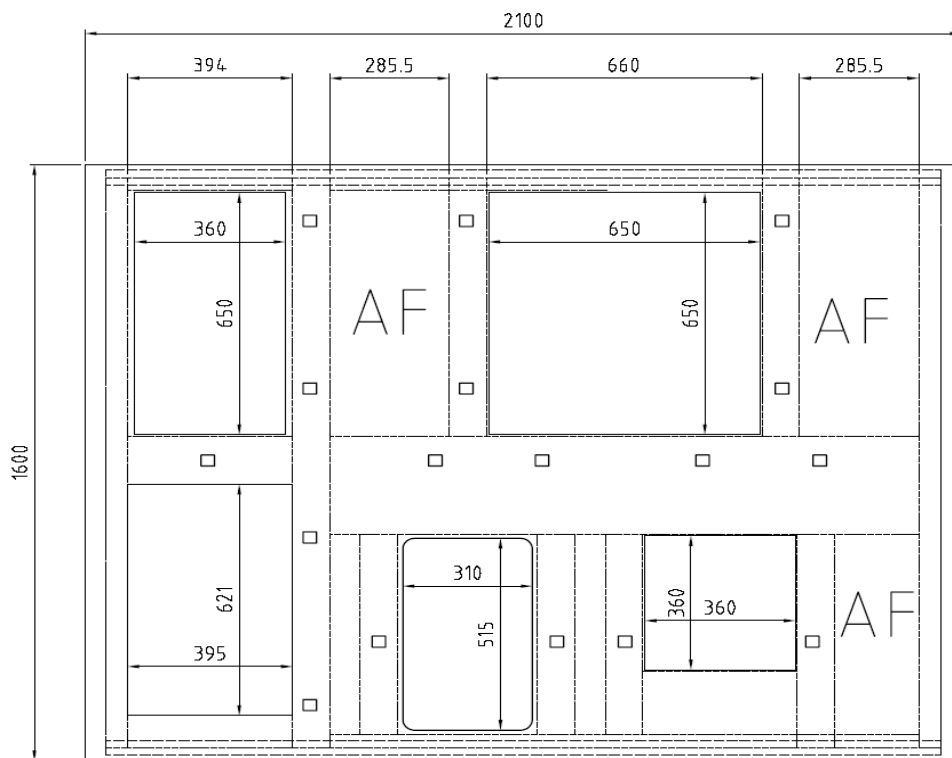
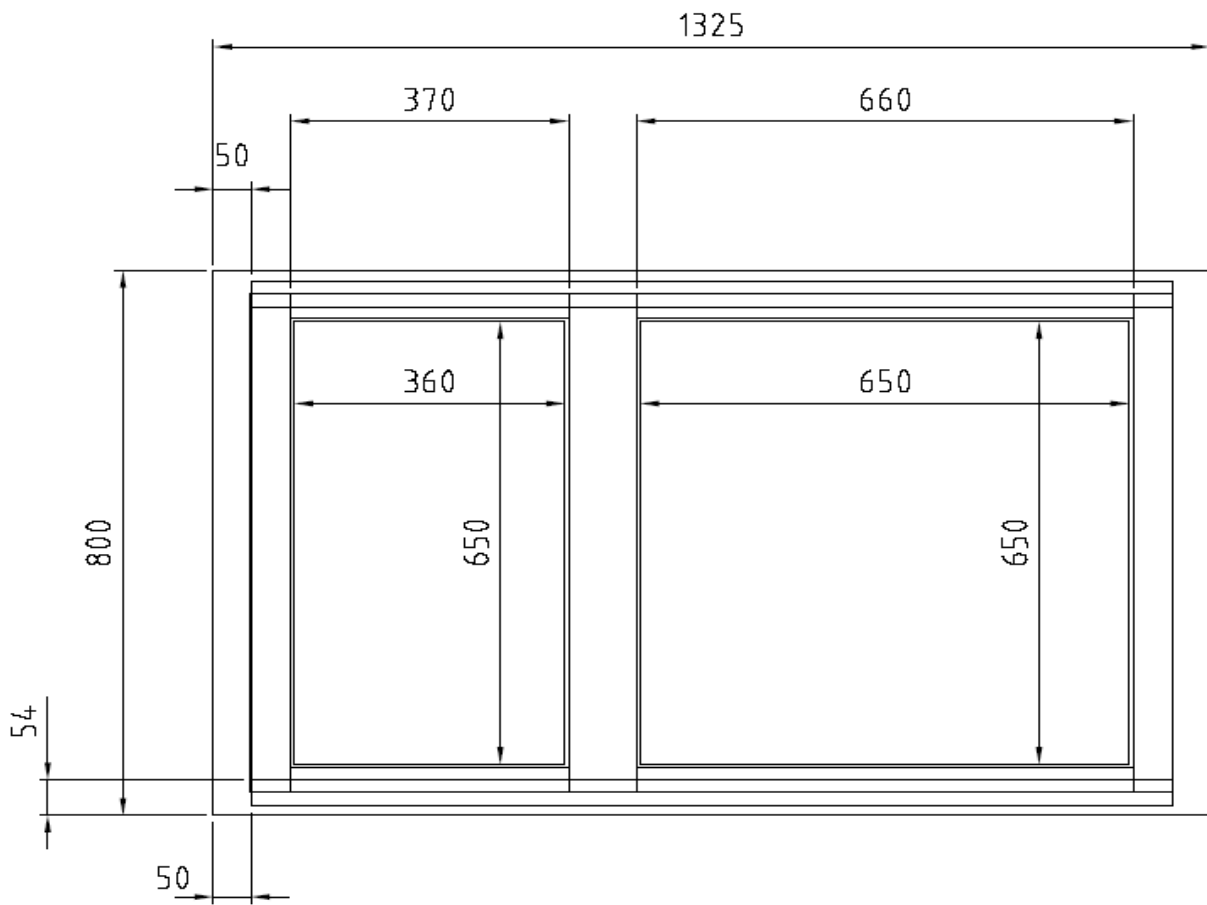

PALUX Maître

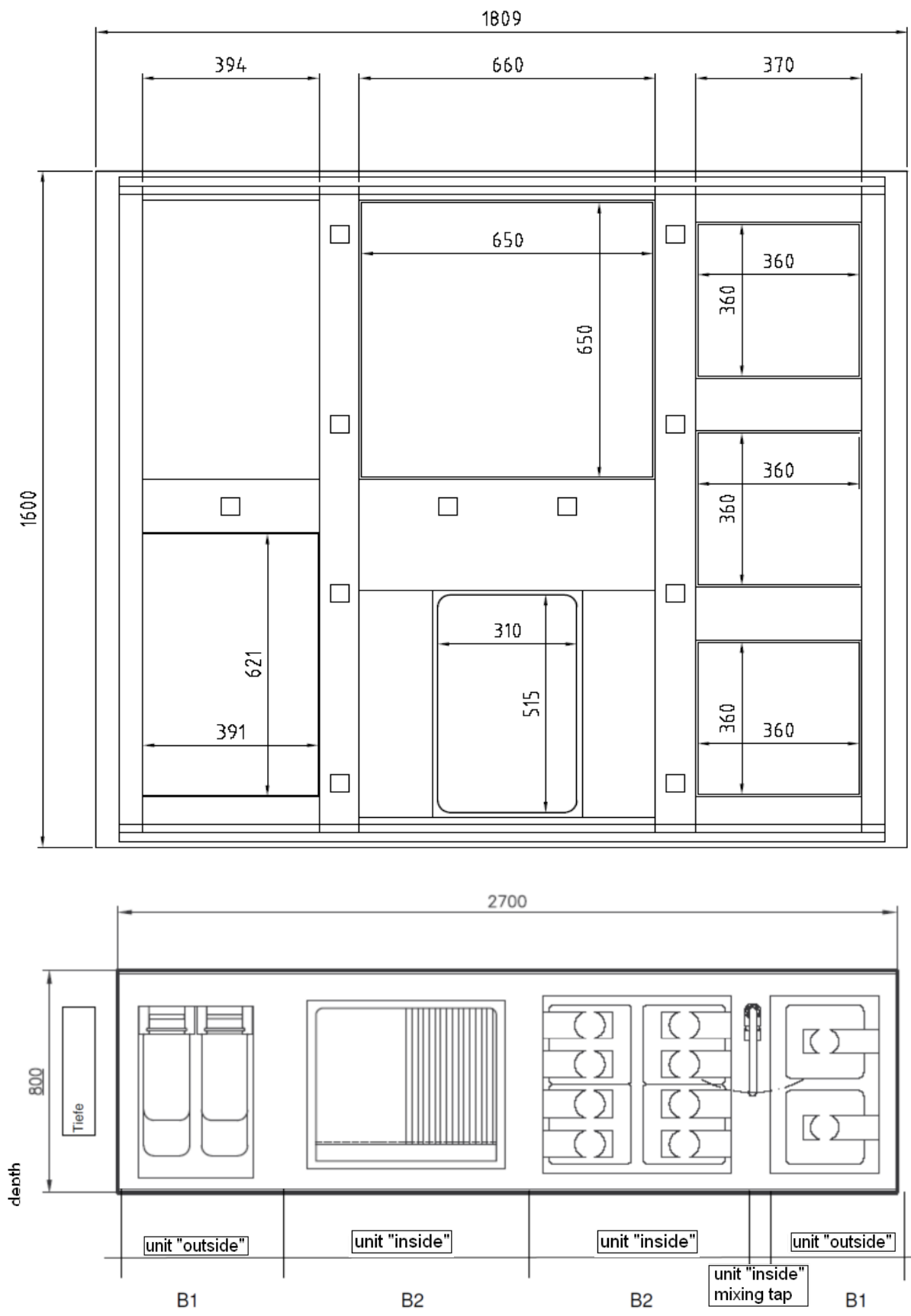

PALUX Maître

PALUX Maître

PALUX Maître

PALUX Maître

Art. No. 884432

PALUX Aktiengesellschaft
Wilhelm-Frank-Straße 36
97980 Bad Mergentheim
GERMANY
Tel.: +49 (0) 7931 / 55 0
Fax: +49 (0) 7931 / 55 88 0
Internet: www.palux.de
E-Mail: info@palux.de

PALUX

Die große Freiheit